

Controlflex[®]
Cabos + mais



AFTERMARKET
Controlflex[®]
UMA DIVISÃO CONTROLFLEX GROUP

CATÁLOGO DE PEÇAS



Vini[®]
by Controlflex

AFTERMARKET
Controlflex[®]
UMA DIVISÃO CONTROLFLEX GROUP

Desde 1986, a Controlflex trabalha diariamente em busca de inovação. Neste catálogo, você encontrará toda essa inovação em peças para motocicletas **Vini e Controlflex Cabos** que surpreendem quando o assunto é qualidade.

A linha Vini, oferecida através da parceria com os principais fornecedores de motopeças do mundo, apresenta produtos com o melhor custo-benefício.

Os cabos de comando da Controlflex garantem a mesma qualidade dos originais, que são elaborados para garantir o melhor desempenho.

CONTROLFLEX CABOS E PEÇAS VINI.
COM ESSA QUALIDADE, VOCÊ VAI LONGE.



Vini[®]
by Controlflex

A marca **Vini by Controlflex** é resultado da parceria da empresa com fornecedores de peças originais para as principais montadoras do mundo.



SUMÁRIO

♦ MOTOR e suas partes

- 06** BALANCIM
- 07** BIELA
- 08** BIELA MODIFICADA
- 09** BOMBA DE ÓLEO
- 10** BRAÇO OSCILANTE
- 10** CARBURADOR + KIT REPARO CARBURADOR (AGULHA E SEDE)
- 12** CHAVETA
- 12** CHAVETA + CHAPÉU DE VÁLVULA (2 QTD)
- 12** COMANDO DE VÁLVULAS
- 15** CORRENTE DE COMANDO
- 16** GUIA E TENSOR
- 16** KIT CILINDRO
- 18** PINO CURSADO
- 18** PISTÃO + ANÉIS
- 23** RETENTOR DE VÁLVULA
- 23** VÁLVULA

♦ ELÉTRICO e suas partes

- 30** BOBINA DE IGNIÇÃO
- 30** MOTOR DE PARTIDA
- 31** SENSOR DE VELOCÍMETRO

♦ EMBREAGEM e suas partes

- 34** CUBO E PLATÔ
- 34** DISCO DE EMBREAGEM
- 35** EIXO SECUNDÁRIO
- 42** EMBREAGEM PRIMÁRIA COMPLETA
- 43** EMBREAGEM PESO PRIMÁRIO
- 43** KIT EMBREAGEM
- 44** PLACA DE PARTIDA
- 44** ROLETES CONTRAPESO DE VELOCIDADE
- 45** SEPARADOR DE DISCO DE EMBREAGEM

♦ CHASSI e suas partes

- 48** AMORTECEDORES
- 49** CAIXA DE DIREÇÃO
- 50** CILINDRO DE BENGALA
- 51** CILINDRO DE FREIO
- 51** CORREIA DE TRANSMISSÃO
- 52** ENGRENAGEM DO VELOCÍMETRO
- 53** FLEXÍVEL DE FREIO
- 54** PAINEL
- 56** PEDAL DE CÂMBIO
- 58** PEDAL DE FREIO
- 59** PEDAL DE PARTIDA
- 59** PINÇA DE FREIO
- 60** RAIO E NIPLE
- 61** TORNEIRA DE COMBUSTÍVEL

♦ CABO + mais

- 63** CABO DE ACELERADOR
- 65** CABO DE AFOGADOR
- 66** CABO DE CONTAGIRO
- 66** CABO DE EMBREAGEM
- 68** CABO DE FREIO
- 69** CABO DE VELOCÍMETRO

#vádevini

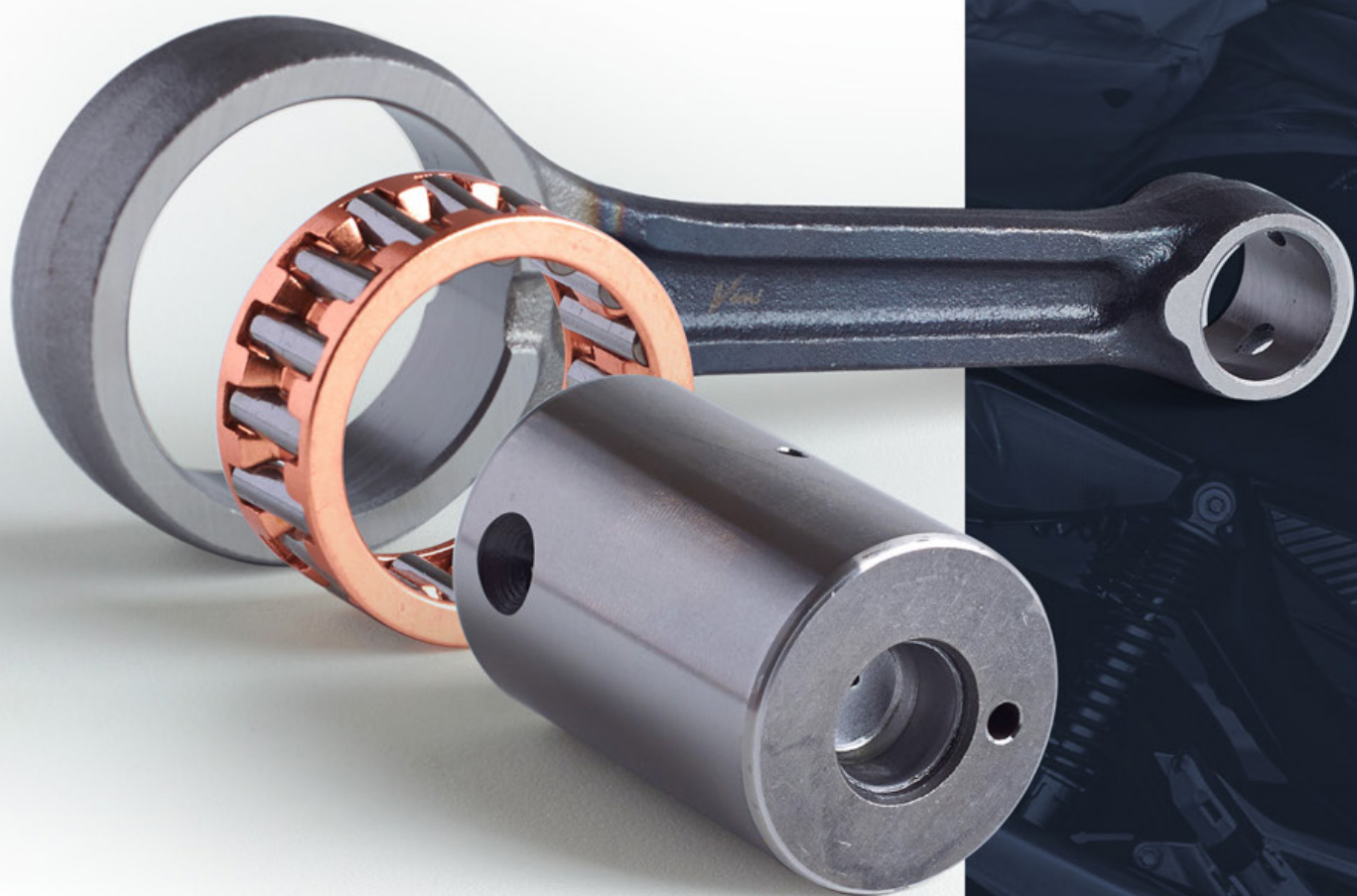

ORIGINAL
da
Lata

motor
(e suas partes)

ORIGINAL
da
Lata

SE É **VINI**

PODE CONFIAR



Vini
by Controlflex

Com **peças de motor Vini**,
você vai muito mais longe.

BALANÇIM

Buscando prolongar a vida útil do produto, o Balançim Vini é fabricado com liga de alta qualidade, que garante a resistência necessária para o funcionamento correto do motor.

DAFRA

9020860015	LASER 150 - ADMISSÃO/ESCAPE (1 PEÇA)
9020860022	RIVA 150 / COMET 150 - ADMISSÃO/ESCAPE (1 PEÇA)

HONDA

9020860023	BIZ 100 2013 E.D. / POP 100 2007 E.D. - ADMISSÃO/ESCAPE (1 PEÇA)
9020860020	BIZ 125 2011 E.D. - ADMISSÃO/ESCAPE (1 PEÇA)
9020860003	C100 DREAM 92-98 / BIZ 100 98-05 / XY 50Q - ADMISSÃO/ESCAPE (1 PEÇA)
9020860004	CG 125 ML TURUNA TODAY 73-91 - BALANÇERO COMPLETO
9020860002	CG 125 TODAY 92-99 / CG 125 TITAN 00-04 / CG 125 FAN 05-08/ NXR 125 BROS 03-05 - ADMISSÃO (1 PEÇA)
9020860011	CG 125 TODAY 92-99 / CG 125 TITAN 00-04 / CG 125 FAN 05-08 / NXR 125 BROS 03-05 - BALANÇERO COMPLETO
9020860006	CG 125 TODAY 92-99 / CG 125 TITAN 00-04 / CG 125 FAN 05-08/ NXR 125 BROS 03-05 - ESCAPE (1 PEÇA)
9020860010	CG 150 TITAN 04-08 / CG 150 TITAN FAN 2009 E.D. / CG 125 FAN 2009 E.D. / NXR 150 BROS 2006 E.D. / NXR 125 BROS 2013 E.D. - ADMISSÃO/ESCAPE (1 PEÇA)
9020860019	CG 150 TITAN 04-08 / CG 150 TITAN FAN 2009 E.D. / CG 125 FAN 2009 E.D. / NXR 150 BROS 2006 E.D. / NXR 125 2013 E.D. - BALANÇERO COMPLETO
9020860028	CG 160 TITAN FAN START 2016 / NXR 160 BROS 2016 - ADMISSÃO/ESCAPE (1 PEÇA)
9020860001	CRF 230 2003 E.D. / XR 200 95-02 / CBX 200 94-00 / CG 125 TURUNA ML 85-89 / NXR 150 03-05 / NX 200 93-00 - ADMISSÃO/ESCAPE (1 PEÇA)
9020860029	LEAD 110 2010 E.D. - ADMISSÃO (1 PEÇA)
9020860030	LEAD 110 2010 E.D. - ESCAPE (1 PEÇA)
9020860032	NX400/400i FALCON - ADMISSÃO "A" (1 PEÇA)
9020860033	NX400/400i FALCON - ESCAPE "B" (1 PEÇA)
9020860031	NX400/400i FALCON - ADMISSÃO/ESCAPE "C" (1 PEÇA)
9020860026	PCX 150 ATE 2015 - ADMISSÃO (1 PEÇA)
9020860036	BIZ-110i / POP-110i 2016 E.D.



SUNDOWN

9020860024	FUTURE 125 05-14 - ADMISSÃO/ESCAPE (1 PEÇA)
------------	---------------------------------------------

SUZUKI

9020860021	BURGMAN 125 05-10 - ADMISSÃO/ESCAPE (1 PEÇA)
9020860034	BURGMAN 125i 2011 E.D. ADMISSÃO/ESCAPE (1 PEÇA)
9020860013	YES 125 / INTRUDER 125 / KATANA 125 - ADMISSÃO/ESCAPE (1 PEÇA)

TRAXX

9020860014	STAR 50 - ADMISSÃO/ESCAPE (1 PEÇA)
------------	------------------------------------

YAMAHA

9020860017	TT-R 230 2008 E.D. / XT 225 96-06 - ADMISSÃO/ESCAPE (1 PEÇA)
9020860005	YBR 125 00-08 / YBR 125 FACTOR 2009 E.D. / XTZ 125 2003 E.D. / TTR 125 2008 E.D. - ADMISSÃO/ESCAPE (1 PEÇA)
9020860025	YS 150 FAZER 2014 E.D. / XTZ 150 CROSSER 2014 E.D. - ADMISSÃO/ESCAPE (1 PEÇA)
9020860007	YS 250 FAZER 2006 E.D. / XTZ 250 LANDER 2007 E.D. / XTZ 250 TENERE 2011 E.D. - ADMISSÃO/ESCAPE (1 PEÇA)

BIELA

As Bielas Vini possuem um tempo de vida útil maior graças a processos de tratamento térmico, maior lubrificação e atrito reduzido entre biela, rolamento e pino.

DAFRA

9020810156	APACHE 150 (PINO Ø 15mm)
9020810089	HUNTER 90 / HUNTER 100 / SUPER 100 (PINO Ø 13mm)
9020810088	LASER 150 / GARINI 150 (PINO Ø 15mm)
9020810217	RIVA 150 (PINO Ø 15mm)

HONDA

9020810346	BIZ 110i / POP 110i 2016 E.D (PINO Ø 13mm)
9020810005	BIZ 125 2006 E.D. (PINO Ø 13mm)
9020810007	C100 DREAM 92-98 / BIZ 100 1998 E.D. / POP 100 2007 E.D. (PINO Ø 13mm)
9020810367	CB 250 TWISTER 2015 E.D (PINO Ø 17mm)
9020810200	CB300R 2010 E.D. / XRE300E 2010 E.D. (PINO Ø 18mm)
9020810013	CBX 250 TWISTER / XR 250 TORNADO (PINO Ø 17mm)
9020810091	CG / TODAY 92-01 / TITAN 99-01 / CBX 200 / NX 200 (PINO Ø 16mm)
9020810003	CG 125 / ML / TUR 77/82 (PINO Ø 13mm)
9020810002	CG 125 83-91 / XL125 84-96 / KANSAS 150 08-14 / SPEED 150 08-14 (PINO Ø 15mm)
9020810093	CG 125 FAN 2009 E.D. (PINO Ø 13mm)
9020810158	CG 125 TITAN 02-04 / CG 125 FAN 05-08 / NXR 125 BROS 03-05 (PINO Ø 15mm)
9020810004	CG 125 TITAN 02-04 / FAN 05-08 / NXR 125 BROS 03/05 (PINO Ø 13mm)
9020810001	CG 125 TODAY 92-01 / TITAN 99-01 / CBX 200 / NX 200 (PINO Ø 15mm)
9020810157	CG 150 TITAN 04-08 / CG 150 TITAN FAN 09-15 / NXR 150 BROS 06-15 (PINO Ø 15mm)
9020810006	CG 150 TITAN 04-08 / CG 150 TITAN FAN 2009 E.D. / NXR 150 BROS 2006 E.D. (PINO Ø 14mm)
9020810337	CG 160 TITAN FAN 2016 / NXR 160 BROS 2016 / XRE 190 2016 E.D (PINO Ø 18mm)
9020810259	CRF 230 2007 E.D. (PINO Ø 15mm)
9020810216	LEAD 110 (PINO Ø 13mm)
9020810054	NX400 FALCON 1999 E.D. (PINO Ø 20mm)
9020810322	PCX 150 14-15 (PINO Ø 14mm)



SHINERAY

9020810087	XY 50Q / ZIG 50 (PINO Ø 13mm)
------------	-------------------------------

SUZUKI

9020810022	BURGMAN 125 05-10 (PINO Ø 14mm)
9020810275	BURGMAN 125i 2011 E.D (PINO @14mm)
9020810315	YES 125 / INTRUDER 125 / KATANA 125 (PINO Ø 14mm)

TRAXX

9020810090	STAR 50 / MOBY 50 / SKY 50 (PINO Ø 18mm)
------------	------------------------------------------

YAMAHA

9020810011	CRYPTON 105 ATÉ 2005 (PINO Ø 13mm)
9020810160	CRYPTON 115 2010 E.D. (PINO Ø 13mm)
9020810009	FACTOR 125 2009 E.D. / YBR 125 00 - 08 / XTZ 125 2004 E.D. / TTR 125 08 -13 (PINO Ø 15mm)
9020810323	FAZER 150 2014 E.D. / FACTOR 150 2016 E.D. / XTZ CROSSER 150 2014 E.D. (PINO Ø 15mm)
9020810014	FAZER 250 / LANDER 250 / TENERE 250 (PINO Ø 17mm)
9020810321	NEO AT 115 (PINO Ø 15mm)
9020810008	XT 225 96-08 / TDM 225 96-08 / TT-R 230 08-13 (PINO Ø 16mm)

**BIELA
MODIFICADA**

As Bielas Vini possuem um tempo de vida útil maior graças a processos de tratamento térmico, maior lubrificação e atrito reduzido entre biela, rolamento e pino.

Vini[®]
HOT PARTS

**BIELA
HOTPARTS**

**MAIOR
LUBRIFICAÇÃO
MÁXIMO
DESEMPENHO!**



HONDA

- 9020810091** CG / TODAY 92-01 / TITAN 99-01 / CBX 200 / NX 200 (PINO Ø 16MM)
- 9020810158** CG 125 TITAN 02-04 / CG 125 FAN 05-08 / MXR 125 BROS 03-05 (PINO Ø 15MM)
- 9020810157** CG 150 TITAN 04-08 / CG 150 TITAN FAN 2009 E.D. / MXR 150 BROS 2006 E.D. (PINO Ø 15MM)

Vini[®]
by ControlFlex

BOMBA DE ÓLEO

A bomba de óleo é o componente responsável pela lubrificação forçada de todas as partes móveis do motor da motocicleta. Por essa razão, ela é considerada o "coração" do veículo, pulsando óleo para que todo o sistema funcione da melhor forma possível. E na Vini, ela é elaborada seguindo o mesmo padrão de qualidade do original.

HONDA



9020**880254**

BIZ 100 / POP 100 / C100 DREAM



9020**880255**

BIZ 125 2006 E.D.



9020**880259**

CG FAN 125 05-08 / CG TITAN125 00-04 31D



9020**880257**

CG 125 (83-91) 3TD



9020**880258**

CG 125 (92-99) 31D



9020**880260**

CG 150 TITAN 2004 E.D. / CG 125 2009 E.D.
/ NXR 150 BROS 2006 E.D.



9020**880534**

CG 160 TITAN / FAN 2016 E.D. / NXR 160 B
ROS 2015 E.D. / XRE 190 2016 E.D.



9020**880261**

NXR 125 BROS 03-05 31D

SUZUKI



9020**880472**

YES 125 / INTRUDER 125



9020**880262**

CRYPTON 105 ATÉ 2005



9020**880263**

FACTOR 125 2009 E.D. / YBR 125 00-08



9020**880579**

YBR FACTOR 125i 2017 E.D. / YS FAZER 150
2014 E.D. / YBR FACTOR 150i

YAMAHA

BRAÇO OSCILANTE



HONDA

9020**860009**

CG 125 CARGO TODAY 92-99 / TITAN FAN 00-08

9020**860008**

CG 125 ML / CARGO / TODAY ATÉ 91

CARBURADOR

O Carburador Vini segue o padrão de qualidade e regulagem dos originais. Isso porque o processo de fabricação das peças de reposição é feito por fornecedores das maiores montadoras do mundo, além de contar com diversas aplicações para os modelos de motos mais populares.

DAFRA



9020**840062**

SUPER 100 2008 E.D.



ORIGINAL
da
Lata

HONDA



9020**840034**

BIZ / C100 DREAM 92-98



9020**840071**

BIZ 100 13-15



9020**840032**

BIZ 100 99-05 COM AFOGADOR FIXO



90.20**840035**

BIZ 125 06-08



90.20**840066**

CBX 200 94-02 / NX 200 94-02 / XR 200R 94-02



90.20**840065**

CBX 250 TWISTER 01-08



9020**840026**

CG 125 FAN 04-08 / CG 125 TITAN 02-03 / CG 125 TITAN 95-01 / CG125 TODAY ML TURUNA 81-94 / XL125 84-00 / CG 125 ML TURUNA 76-89



9020**840077**

CG 125 FAN 2009 E.D.



9020**840029**

CG 150 TITAN 04-08 / NXR 150 BROS 06-08 / NXR 125 BROS 2013 E.D.



9020**840064**

CG 150 TITAN SPORT 04-08



9020**840085**

NX400 FALCON 99-08



9020**840036**

POP 100 07-15

SHINERAY



9020840041

PHOENIX 50 / STAR 50 / SKY 50



9020840023

XY50Q

SUZUKI



9020840086

BURGMAN125 05-10



9020840067

YES 125 05-10 / INTRUDER 125 06-10 COM AFOGADOR FIXO

YAMAHA



9020840072

CRYPTON T105 98-05



9020840073

CRYPTON T115 10-15



9020840037

XTZ 125 03-08



9020840038

YBR125

KIT REPARO CARBURADOR (AGULHA / SEDE)

HONDA

9020840079

BIZ 125 05-10

(AGULHA)

9020840080

CG 125 TITAN 00-04 / CG 125 FAN
05-08

(AGULHA E SEDE)

9020840082

CG TITAN 150 04-08 / CG FAN
125 09-15

(AGULHA E SEDE)

YAMAHA

9020840078

YBR 125 00-08 / XTZ 125 03-08

(AGULHA E SEDE)

Vini
HOT PARTS

**CARBURADOR
HOTPARTS**

**MÁXIMO
EM POTÊNCIA
E DESEMPENHO!**

9020840091

CARBURADOR ESPORTIVO 30MM 125CC ATÉ 250CC
+ FILTRO DE AR + COLETOR DE ADMISSÃO



Vini
Control flex

CHAVETA

HONDA

9020890069 CG 125 2009 E.D / CG 150 TITAN 04-15 / CG 150 FAN 09-15 / NXR 125 BROS 13-14 / NXR 150 BROS 06-15 /

9020890060 CG TITAN 125 83-91

9020890070 CG TODAY / TITAN 92 -01 / XLR 125 97 - 01

SUZUKI

9020890071 BURGMAN 125 / YES 125

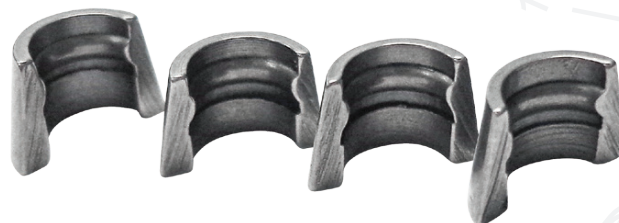

ESTABILIDADE
QUE FAZ
DIFERENÇA

CHAVETA + CHAPÉU DE VÁLVULA (2 PÇS)

HONDA

9020890090 CG 125 2009 E.D. / CG 150 TITAN 2004 E.D. / CG 150 FAN 2009 E.D. / NXR 125 BROS 2013 E.D. / NXR 150 BROS 2006 E.D. / BIZ 100 1998 E.D. / C100 DREAM 92-98/ POP 100 2007 E.D.

COMANDO DE VÁLVULAS

Responsável pela abertura e fechamento das válvulas no motor, o Comando de Válvulas Vini garante potência para a moto.

DAFRA



9020850073

APACHE 150



9020850074

COMET 150

HONDA



9020850034

BIZ 100 13-14 / POP 100 2007 E.D.



9020850104

BIZ 110i / POP 110i



9020850051

BIZ 125 2005 E.D.

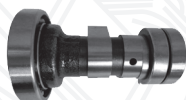

9020**850001**

C100 DREAM 98-01 / BIZ 100 02-05



9020**850122**

CB 250 TWISTER INJ 2016 E.D.



9020**850053**

CB 300R 09-15 / XRE 300R 09 E.D. / CBX 250 TWISTER 01-08 / XR 250 TORNADO 01-08 (ADMISSÃO)



9020**850052**

CB 300R 09-15 / XRE 300R 09 E.D. / CBX 250 TWISTER 01-08 / XR 250 TORNADO 01-08 (ESCAPE)



9020**850004**

CG 125 00-04 / CG FAN 125 05-08 / NXR BROS 125 03-05 (ÁRVORE DE COMANDO COMPLETA)



9020**850003**

CG 125 2009 E.D. / CG 150 TITAN 04-15 / 150 FAN 09-15 / NXR BROS 150 06-15 / NXR BROS 125 2013 E.D.



9020**850002**

CG 125 83-99 (ÁRVORE DE COMANDO COMPLETA)



9020**850101**

CG 160 TITAN FAN START 2016 E.D. / NXR 160 BROS 2016 E.D.



9020**850047**

CRF 230 / BROS 150 OHC ATÉ 2005 / CBX 200 94-02 / XR 200 93-01 / NX 200 93-01 / NX 150 90-93 / CBX 150 88-94



9020**850095**

LEAD 110 2010 E.D.



9020**850094**

PCX 150 2014 E.D.



9020**850103**

XRE 190 2016 E.D.

SUNDOWN



9020**850089**

FUTURE 125 05-14 / LASER 150 08-10

SUNDOWN / DAFRA



9020**850029**

HUNTER 100 07-09 / WEB 100 02-09 / WEB EVO 100 06-09 / SUPER 100 08-14

SUZUKI



9020**850045**

YES 125 / INTRUDER 125 / KATANA 125

TRAXX



9020**850057**

STAR 50 / ZIG 50

YAMAHA



9020**850050**

CRYPTON 105 ATÉ 2005



9020**850092**

CRYPTON 115 2010 E.D. / NEO 115



9020**850044**

FACTOR 125 2009 E.D. / YBR 125 06-08 / XTZ 125 2006 E.D. / TTR 125 08-13



9020**850121**

FAZER 250 2019 E.D. / LANDER 250 2019 E.D.



9020**850032**

XT 225 96-08 / TT-R 230 08-13



9020**850049**

YBR 125 00-05 / XTZ 125 03-05



9020**850124**

YBR FACTOR 125i 2017 E.D.

DIVERSOS



9020**850035**

XY 50Q / HYPE 50 / SOFT 50 / PHOENIX 50 / STAR 50 / ZIG 50 / BRAVAX 50 / JOY 50

ORIGINAL
Lata



Vini[®]
HOT PARTS

**COMANDO
DE VÁLVULAS
HOTPARTS**

**POTÊNCIA
MÁXIMA DA MOTO**



**RESSALTO DO
COMANDO HOTPARTS**

9020850085

CG 125 83-99 (MODIFICADO)

9020850086

TITAN 2000 00-04 / FAN 05-08
(MODIFICADO)

HONDA

9020850090 CB 300R 09-15 / XRE 300R 09 E.D. / CBX 250 TWISTER 01-08 / XR 250
TORNADO 01-08 (MODIFICADO ADM - ESC)

9020850087 CG 125 2009 E.D. / CG 150 TITAN 04-15 / 150 FAN 09-15 / NXR BROS 150
06-15 / NXR BROS 125 2013 E.D. (MODIFICADO)

9020850119 CG 160 FAN / TITAN (MODIFICADO)

9020850088 CRF 230 / BROS 150 OHC ATÉ 2005 / CBX 200 94-02 / XR 200 93-01 /
NX 200 93-01 / NX 150 90-93 / CBX 150 88-94 (MODIFICADO)

YAMAHA

9020850091 FACTOR 125 2009 E.D. / YBR 125 00-08 / XTZ 125 2003 E.D. / TTR 125
08-13 (MODIFICADO)

Vini[®]
by Controlflex

CORRENTE DE COMANDO

As Correntes de Comando Vini são produzidas por prensas automáticas de alta velocidade e ferramentas de estampagem de alta precisão, que garantem a conformabilidade do tamanho dos elos. As correntes são 100% testadas antes de deixar a fábrica para evitar desgaste e ruptura no estágio inicial de uso.

DAFRA

9020**850058** APACHE 150 (2X3LW X 94L)

DIVERSOS

9020**850011** CG 125 ML TURUNA / XL 125 / XLS 125 / KATANA 125 96-00 / INTRUDER 125 2002 E.D. / CRYPTON 105 98-05 (25H X 98L)

9020**850014** NX 150 90-93 / CBX 150 AERO 88-92 / COMET 150 09-12 / RIVA 150 11-13 / CITYCOM 300i 2010 E.D. (2X3LW X 100L)

9020**850061** STAR 50 / SKY 50 / MOBY 50 / HYPE 50 / SOFT 50 / PHOENIX / JET 50 (25H X 82L)

HONDA

9020**850009** BIZ 100 1998 E.D. / POP 100 2007 E.D. / C100 DREAM 92-98 (25H X 84L)

9020**850025** BIZ 125 2005 E.D. / ELITE 125 / PCX 150 2014 E.D. / BURGMAN 125i 11-18) (2X3LW X 92L)

9020**850013** CG 150 TITAN 04-08 / CG 150 TITAN FAN 2009 E.D. / CG 125 TITAN FAN 2009 E.D. / NXR 150 BROS 2006 E.D. / NXR 125 BROS 2013 E.D. (2X3LW X 94L)

9020**850120** CB250 TWISTER INJ 2016 E.D (409X102L)

9020**850015** NX/CBX STRADA/XR 200 (2X3LW X 102L)

9020**850016** NX4 FALCON 1999 E.D. (3X4LN X 112L)

9020**850102** POP 110i 2016 E.D. / BIZ 110i 2016 E.D. (25H X 90L)

9020**850019** XLX 250 / XLX/NX SAHARA 350 (4X5LW X 108L)

9020**850017** XR 250 TORNADO 01-08 / CBX 250 TWISTER 01-08/ CB 300R 10-15/ XRE 300 2010 E.D 3X4LN X 126L

9020**850099** XRE 190 2016 E.D. / CG 160 TITAN FAN START 2016 E.D. / NXR 160 BROS 2016 E.D. (2X3LW X 98L)



YAMAHA

9020**850012** XT 225 96-06 / TTR 230 2008 E.D. / TDM 225 97-04 (25H X 104L)

9020**850010** YBR 125 00-05 / XTZ 125 03-05 (25H X 88L)

9020**850026** YBR 125 2006 E.D. / XTZ 125 2006 E.D. / CRYPTON 115 2010 E.D. / TTR 125 2008 E.D. / NEO 06-12 / LEAD 110 09-13 (2X3LW X 90L)

9020**850100** YS 150 FAZER 2014 E.D. / XTZ 150 CROSSER 2014 E.D. / YBR 150 FACTOR 2016 E.D. (2X3LW X 96L)

9020**850027** YS 250 FAZER 06 E.D. / XTZ 250 LANDER 07-14 / XTZ 250 TÉNÉRÉ 2011 E.D. / CRF 230 2008 E.D. (2X3LW X 104L)

GUIA E TENSOR

Vini
HOT PARTS

HONDA

9020850077	BIZ 125 2005 E.D.
9020850105	CBX 250 TWISTER 00-08 / XR 250 TORNADO 01-08
9020850078	CG 150 TITAN 04-08 / CG 125 09-15 / FAN 150 09-15 / BROS 150 06-15
9020850118	CG 160 TITAN FAN START 2016 E.D. / NXR 160 BROS 2015 E.D. / XRE 190 2016 E.D.
9020850110	NX 400 / 400i FALCON 99-15
9020840104	NX4 FALCON 03-15 COM CATALISADOR
9020840087	NX4 FALCON 99-05 SEM CATALISADOR
9020850111	XR 200 94-03 / NX 200 93-01 / CBX 200 93-03

SUNDOWN

90.20850109	FUTURE 125 05-14
-------------	------------------

SUZUKI

9020850115	YES 125
------------	---------

YAMAHA

9020850106	CRYPTON 105
9020850107	CRYPTON 115
9020850114	YBR125 / XTZ125
9020850108	YS FAZER 150 2014 E.D. / XTZ CROSSER 150 2015 E.D. / YBR FACTOR 150 2017 E.D. / YBR FACTOR 125 2017 E.D.
9020850113	YS 250 FAZER 06-17 / XTZ 250 LANDER 07-18 / XTZ 250 TENERE 11-18

KIT CILINDRO (PISTÃO + ANÉIS)

Os Kits Cilindro Vini se destacam pela sua ótima resistência ao desgaste e à abrasão, além de sua perfeita vedação, que garante o desempenho máximo do motor. As dimensões precisas da peça ainda asseguram estabilidade no uso e evitam choques e impactos entre o pistão e a camisa do cilindro.

DAFRA

9020840011	LASER 150 08-10
9020840043	RIVA 150 2011 E.D.

HONDA

9020840076	BIZ 110i / POP 110i
9020840005	BIZ 125 05-08
9020840045	BIZ 125 2009 E.D.
9020840075	CB 300 / XRE 300 2009 E.D.
9020840046	CBX 200 94-02 / NX 200 94-02 / XR 200R 94-02
9020840053	CBX 250 TWISTER 01-08 / XR 250 TORNADO 01-08
9020840003	CG 125 FAN 04-08 / CG 125 TITAN 02-03 / NXR BROS 125 03-05
9020840015	CG 125 FAN 2009 E.D. / NXR 125 BROS 2013 E.D.
9020840001	CG 125 83-91 / MLTURUNA 85-88
9020840007	CG 125 TITAN TODAY 95-01



9020840013	CG 125 TODAY 88-94 / CG 125 TITAN 95-99
9020840004	CG 150 FAN 09-15 / CG 150 TITAN 04-15 / NXR 150 BROS 06-15
9020840069	CG 160 TITAN FAN START 2016 / NXR 160 BROS 2016
9020840052	CRF 230 2007 E.D.
9020840104	NX4 FALCON 03-15 COM CATALISADOR
9020840087	NX4 FALCON 99-05 SEM CATALISADOR
9020840002	POP 100 07-15 / BIZ 100 02-05 / C100 DREAM 98-01
9020840074	XRE 190 2016 E.D.

KASINSKI

9020**840044** COMET 150 09-13

SUNDOWN

9020**840012** FUTURE 125 05-14

SUZUKI

9020**840018** BURGMAN 125 05-10

9020**840088** BURGMAN 125i 2011 E.D.

9020**840017** INTRUDER 125 08 E.D.

9020**840008** YES 125 05-12

YAMAHA

9020**840014** CRYPTON 105 98-05 / ZIG 100 09-14

9020**840042** CRYPTON 115 2010 E.D.

9020**840006** YBR 125 FACTOR 2009 E.D. / YBR 125 00-08 / XTZ 125 2004 E.D. / TTR 125 08-13

9020**840090** YBR 125 FACTOR 2017 E.D.

9020**840070** YBR 150 FACTOR 2016 E.D. / YS 150 FAZER 2014 E.D. / XTZ 150 CROSSER 2014 E.D.

9020**840089** YS 250 FAZER 2006 E.D. / XTZ 250 LANDER 2007 E.D. / XTZ 250 TENERÉ 11-19

KIT CILINDRO HOTPARTS

VEDAÇÃO QUE GARANTE MÁXIMO DESEMPENHO DO MOTOR!

Vini HOT PARTS

CYLINDER BLOCK CILINDRO COMPLETO

VINI INDUSTRIAL CO. LTD

Vini
Central Flow

HONDA

9020**840060** CG 150 TITAN 04-15 / CG 150 FAN 09-15 / NXR 150 BROS 06-15 MODIFICADO 190CC

9020**840106** CG 160 TITAN FAN START 2016 E.D. / NXR 160 BROS 2016 E.D. MODIFICADO 205CC

9020**840107** XRE 190 MODIFICADO 210CC

YAMAHA

9020**840083** YBR 125 00-08 / XTZ 125 03-14 / YBR 125 FACTOR 09-16 MODIFICADO 150cc

9020**840105** YS 150 FAZER 2014 E.D. / YBR 150 FACTOR 2016 E.D. / XTZ 150 CROSSER 2014 E.D. MODIFICADO 180cc

PINO CURSADO

Os pinos cursados são produtos que promovem o aumento de cilindrada de um motor. Ele fica conectado à biela e às duas partes do virabrequim e o ganho de cilindrada está relacionado à altura de deslocamento do pino. Os Pinos Cursados Vini são produzidos em aço especial, retificados e com tratamento térmico cementação com dureza superficial específica para esta finalidade.

HONDA

9020810370	CBX 250 TWISTER / XR250 TORNADO 2mm
9020810371	CG 125 TITAN 02-04 / FAN 05-08 / NXR 125 BROS 03-05 2mm
9020810368	CG 150 TITAN 04-08 / CG 150 TITAN FAN 09-15 / NXR 150 BROS 06-15 / CG 125 FAN 09-18 / CG 160 TITAN FAN 2016 E.D. / NXR 160 BROS 2015 E.D. 2mm



PISTÃO+ANÉIS

A tecnologia utilizada na produção do Conjunto de Pistões e Anéis Vini possibilita que seu funcionamento tenha maior vedação e equilíbrio, se adeque a maiores temperaturas e trabalhe de modo correto e reto em seu trajeto.

DAFRA

9020810294	APACHE 150 2010 E.D. STD
9020810295	APACHE 150 2010 E.D. +0.25
9020810296	APACHE 150 2010 E.D. +0.50
9020810177	LASER 150 08-10 STD
9020810178	LASER 150 08-10 +0.25
9020810179	LASER 150 08-10 +0.50
9020810180	LASER 150 08-10 +0.75
9020810181	LASER 150 08-10 +1.00
9020810206	RIVA 150 2011 E.D. STD
9020810208	RIVA 150 2011 E.D. +0.25
9020810209	RIVA 150 2011 E.D. +0.50
9020810210	RIVA 150 2011 E.D. +0.75
9020810211	RIVA 150 2011 E.D. +1.00
9020810172	SPEED 150 08-14 STD
9020810173	SPEED 150 08-14 +0.25
9020810174	SPEED 150 08-14 +0.50
9020810175	SPEED 150 08-14 +0.75

HONDA

9020810362	BIZ 110i / POP 110i STD
9020810363	BIZ 110i / POP 110i + 0.25
9020810364	BIZ 110i / POP 110i + 0.50
9020810365	BIZ 110i / POP 110i + 0.75
9020810366	BIZ 110i / POP 110i + 1.00
9020810111	BIZ 125 06-10 STD
9020810112	BIZ 125 06-10 +0.25
9020810113	BIZ 125 06-10 +0.50
9020810114	BIZ 125 06-10 +0.75
9020810115	BIZ 125 06-10 +1.00
9020810027	POP 100 07-15 / BIZ 100 98-05 / C100 DREAM 92-98 STD
9020810028	POP 100 07-15 / BIZ 100 98-05 / C100 DREAM 92-98 +0.25
9020810029	POP 100 07-15 / BIZ 100 98-05 / C100 DREAM 92-98 +0.50





Vini[®]
HOT PARTS

**MÁXIMA
POTÊNCIA
E DESEMPENHO
DA MOTO**



Vini[®]
by Controlflex

9020810030 POP 100 07-15 / BIZ 100 98-05 / C100 DREAM 92-98 +0.75

9020810110 POP 100 07-15 / BIZ 100 98-05 / C100 DREAM 92-98 +1.00

9020810384 CB250 TWISTER INJ 2016 E.D. STD

9020810383 CB250 TWISTER INJ 2016 E.D. +0.25

9020810382 CB250 TWISTER INJ 2016 E.D. +0.50

9020810391 CB250 TWISTER INJ 2016 E.D. +0.75

9020810381 CB250 TWISTER INJ 2016 E.D. +1.00

9020810146 CBX 200 94-02 / NX 200 94-02 / XR 200R 94-02 STD

9020810147 CBX 200 94-02 / NX 200 94-02 / XR 200R 94-02 +0.25

9020810148 CBX 200 94-02 / NX 200 94-02 / XR 200R 94-02 +0.50

9020810149 CBX 200 94-02 / NX 200 94-02 / XR 200R 94-02 +0.75

9020810150 CBX 200 94-02 / NX 200 94-02 / XR 200R 94-02 +1.00

9020810269 CBX 250 TWISTER 01-08 / XR 250 TORNADO 01-08 STD

9020810270 CBX 250 TWISTER 01-08 / XR 250 TORNADO 01-08 +0.25

9020810271 CBX 250 TWISTER 01-08 / XR 250 TORNADO 01-08 +0.50

9020810272 CBX 250 TWISTER 01-08 / XR 250 TORNADO 01-08 +0.75

9020810273 CBX 250 TWISTER 01-08 / XR 250 TORNADO 01-08 +1.0

9020810152 CG 125 FAN 09-18 / NXR 125 BROS 13-15 +0.25

9020810153 CG 125 FAN 09-18 / NXR 125 BROS 13-15 +0.50

9020810154 CG 125 FAN 09-18 / NXR 125 BROS 13-15 +0.75

9020810155 CG 125 FAN 09-18 / NXR 125 BROS 13-15 +1.00

9020810233 CG 125 FAN 09-18 +1.25

9020810234 CG 125 FAN 09-18 +1.50

9020810235 CG 125 FAN 09-18 +1.75

9020810023 CG 125 ML TURUNA 77-91 STD

9020810024 CG 125 ML TURUNA 77-91 +0.25

9020810025 CG 125 ML TURUNA 77-91 +0.50

9020810026 CG 125 ML TURUNA 77-91 +0.75

9020810094 CG 125 ML TURUNA 77-91 +1.00

9020810035 CG 125 TITAN 02-04 / CG 125 FAN 05-08 / NXR 125 BROS 03-05 STD

9020810036 CG 125 TITAN 02-04 / CG 125 FAN 05-08 / NXR 125 BROS 03-05 +0.25

9020810037 CG 125 TITAN 02-04 / CG 125 FAN 05-08 / NXR 125 BROS 03-05 +0.50

9020810038 CG 125 TITAN 02-04 / CG 125 FAN 05-08 / NXR 125 BROS 03-05 +0.75

9020810103 CG 125 TITAN 02-04 / CG 125 FAN 05-08 / NXR 125 BROS 03-05 +1.00

9020810104 CG 125 TITAN 02-04 / CG 125 FAN 05-08 / NXR 125 BROS 03-05 +1.25

9020810105 CG 125 TITAN 02-04 / CG 125 FAN 05-08 / NXR 125 BROS 03-05 +1.50

9020810106 CG 125 TITAN 02-04 / CG 125 FAN 05-08 / NXR 125 BROS 03-05 +1.75

9020810019 CG 125 TODAY 92-94 / CG 125 TITAN 95-02 / XLR 125 97-01 STD

9020810020 CG 125 TODAY 92-94 / CG 125 TITAN 95-02 / XLR 125 97-01 +0.25

9020810021 CG 125 TODAY 92-94 / CG 125 TITAN 95-02 / XLR 125 97-01 +0.50

9020810022 CG 125 TODAY 92-94 / CG 125 TITAN 95-02 / XLR 125 97-01 +0.75

9020810096 CG 125 TODAY 92-94 / CG 125 TITAN 95-02 / XLR 125 97-01 +1.00

9020810097 CG 125 TODAY 92-94 / CG 125 TITAN 95-02 / XLR 125 97-01 +1.25

9020810098 CG 125 TODAY 92-94 / CG 125 TITAN 95-02 / XLR 125 97-01 +1.50

9020810099 CG 125 TODAY 92-94 / CG 125 TITAN 95-02 / XLR 125 97-01 +1.75

9020810039 CG 150 TITAN 04-08 / CG 150 TITAN FAN 09-15 / NXR 150 BROS 06-15 STD

9020810040 CG 150 TITAN 04-08 / CG 150 TITAN FAN 09-15 / NXR 150 BROS 06-15 +0.25

9020810041 CG 150 TITAN 04-08 / CG 150 TITAN FAN 09-15 / NXR 150 BROS 06-15 +0.50

9020810042 CG 150 TITAN 04-08 / CG 150 TITAN FAN 09-15 / NXR 150 BROS 06-15 +0.75

9020810129 CG 150 TITAN 04-08 / CG 150 TITAN FAN 09-15 / NXR 150 BROS 06-15 +1.00

9020810130 CG 150 TITAN 04-08 / CG 150 TITAN FAN 09-15 / NXR 150 BROS 06-15 +1.25

9020810131 CG 150 TITAN 04-08 / CG 150 TITAN FAN 09-15 / NXR 150 BROS 06-15 +1.50

9020810132 CG 150 TITAN 04-08 / CG 150 TITAN FAN 09-15 / NXR 150 BROS 06-15 +1.75

9020810341 CG 160 TITAN FAN START 2016 E.D. / NXR 160 BROS 2015 E.D. STD

9020810342 CG 160 TITAN FAN START 2016 E.D. / NXR 160 BROS 2015 E.D. +0.25

9020810343 CG 160 TITAN FAN START 2016 E.D. / NXR 160 BROS 2015 E.D. +0.50

9020810344 CG 160 TITAN FAN START 2016 E.D. / NXR 160 BROS 2015 E.D. +0.75

9020810345 CG 160 TITAN FAN START 2016 E.D. / NXR 160 BROS 2015 E.D. +1.00

9020810260 CRF 230 2007 E.D. STD

9020810261 CRF 230 2007 E.D. +0.25

9020810262 CRF 230 2007 E.D. +0.50

9020810263 CRF 230 2007 E.D. +0.75

9020810264 CRF 230 2007 E.D. +1.00

9020810266 CRF 230 2007 E.D. +1.50

9020810352 NX 400 / 400i FALCON 99-15 STD

9020810353 NX 400 / 400i FALCON 99-15 + 0.25

9020810354 NX 400 / 400i FALCON 99-15 + 0.50

9020810355 NX 400 / 400i FALCON 99-15 + 0.75

9020**810356** NX 400 / 400i FALCON 99-15 + 1.00

9020**810332** PCX 150 13-15 STD

9020**810333** PCX 150 13-15 +0.25

9020**810334** PCX 150 13-15 +0.50

9020**810357** XRE 190 STD

9020**810358** XRE 190 + 0.25

9020**810359** XRE 190 + 0.50

9020**810360** XRE 190 + 0.75

9020**810361** XRE 190 + 1.00

9020**810377** BURGMAN 125i 2011 E.D. +0.25

9020**810378** BURGMAN 125i 2011 E.D. +0.50

9020**810379** BURGMAN 125i 2011 E.D. +0.75

9020**810380** BURGMAN 125i 2011 E.D. +1.00

9020**810141** YES 125 05-12 / INTRUDER 125 08-14 STD

9020**810142** YES 125 05-12 / INTRUDER 125 08-14 +0.25

9020**810143** YES 125 05-12 / INTRUDER 125 08-14 +0.50

9020**810144** YES 125 05-12 / INTRUDER 125 08-14 +0.75

9020**810145** YES 125 05-12 / INTRUDER 125 08-14 +1.00

KASINSKI

9020**810207** COMET 150 09-12 STD

9020**810212** COMET 150 09-12 +0.25

9020**810213** COMET 150 09-12 +0.50

SHINERAY

9020**810136** XY50Q / ZIG 50 (50cc) STD

9020**810137** XY50Q / ZIG 50 (50cc) +0.25

9020**810138** XY50Q / ZIG 50 (50cc) +0.50

9020**810139** XY50Q / ZIG 50 (50cc) +0.75

9020**810140** XY50Q / ZIG 50 (50cc) +1.00

SUNDOWN

9020**810223** FUTURE 125 05-14 STD

9020**810224** FUTURE 125 05-14 +0.25

9020**810225** FUTURE 125 05-14 +0.50

9020**810226** FUTURE 125 05-14 +0.75

SUZUKI

9020**810182** BURGMAN 125 05-10 STD

9020**810218** BURGMAN 125 05-10 +0.25

9020**810219** BURGMAN 125 05-10 +0.50

9020**810220** BURGMAN 125 05-10 +0.75

9020**810221** BURGMAN 125 05-10 +1.00

9020**810376** BURGMAN 125i 2011 E.D. STD

YAMAHA

9020**810124** CRYPTON 105 98-05 / ZIG 100 09-14 STD

9020**810125** CRYPTON 105 98-05 / ZIG 100 09-14 +0.25

9020**810126** CRYPTON 105 98-05 / ZIG 100 09-14 +0.50

9020**810127** CRYPTON 105 98-05 / ZIG 100 09-14 +0.75

9020**810128** CRYPTON 105 98-05 / ZIG 100 09-14 +1.00

9020**810201** CRYPTON 115 10-16 STD

9020**810202** CRYPTON 115 10-16 +0.25

9020**810203** CRYPTON 115 10-16 +0.50

9020**810204** CRYPTON 115 10-16 +0.75

9020**810205** CRYPTON 115 10-16 +1.00

9020**810347** YS 250 FAZER 2005 E.D. / LANDER 250 2006 E.D. / XTZ 250 TENERÉ 11-19 STD

9020**810348** YS 250 FAZER 2005 E.D. / LANDER 250 2006 E.D. / XTZ 250 TENERÉ 2011 E.D. + 0.25

9020**810349** YS 250 FAZER 2005 E.D. / LANDER 250 2006 E.D. / XTZ 250 TENERÉ 2011 E.D. + 0.50

9020**810350** YS 250 FAZER 2005 E.D. / LANDER 250 2006 E.D. / XTZ 250 TENERÉ 2011 E.D. + 0.75

9020**810351** YS 250 FAZER 2005 E.D. / LANDER 250 2006 E.D. / XTZ 250 TENERÉ 2011 E.D. + 1.00

9020**810043** YBR 125 00-16 / XTZ 125 03-14 / TTR 125 08-13 STD

9020**810044** YBR 125 00-16 / XTZ 125 03-14 / TTR 125 08-13 +0.25

9020**810045** YBR 125 00-16 / XTZ 125 03-14 / TTR 125 08-13 +0.50

9020**810116** YBR 125 00-16 / XTZ 125 03-14 / TTR 125 08-13 +0.75

9020**810117** YBR 125 00-16 / XTZ 125 03-14 / TTR 125 08-13 +1.00

9020**810327** YBR 150 FACTOR 2016 E.D. / YS 150 FAZER 2014 E.D. / XTZ 150 CROSSER 2014 E.D. STD

9020**810328** YBR 150 FACTOR 2016 E.D. / YS 150 FAZER 2014 E.D. / XTZ 150 CROSSER 2014 E.D. +0.25

9020**810329** YBR 150 FACTOR 2016 E.D. / YS 150 FAZER 2014 E.D. / XTZ 150 CROSSER 2014 E.D. +0.50

9020810330	YBR 150 FACTOR 2016 E.D. / YS 150 FAZER 2014 E.D. / XTZ 150 CROSSER 2014 E.D. +0.75
9020810331	YBR 150 FACTOR 2016 E.D. / YS 150 FAZER 2014 E.D. / XTZ 150 CROSSER 2014 E.D. +1.00
9020810389	YBR 125i FACTOR 125i 2017 E.D. STD
9020810388	YBR 125i FACTOR 125i 2017 E.D. +0.25
9020810387	YBR 125i FACTOR 125i 2017 E.D. +0.50
9020810386	YBR 125i FACTOR 125i 2017 E.D. +0.75
9020810385	YBR 125i FACTOR 125i 2017 E.D. +1.00

HONDA



9020810256	C100 DREAM 92-98 / BIZ 100 98-15 / POP 100 07-15 MODIFICADO 110CC +0.50 Ø52.85
9020810258	C100 DREAM 92-98 / BIZ 100 98-15 / POP 100 07-15 MODIFICADO 110CC +1.00 Ø53.35
9020810236	CG 125 FAN 09-18 +2.00 Ø54.40
9020810237	CG 125 FAN 09-18 +3.00 Ø55.40
9020810238	CG 125 FAN 09-18 +4.00 Ø56.40
9020810100	CG 125 TODAY 92-94 / CG 125 TITAN 95-02 / XLR 125 97-01 +2.00 Ø58.50
9020810101	CG 125 TODAY 92-94 / CG 125 TITAN 95-02 / XLR 125 97-01 +3.00 Ø59.50
9020810102	CG 125 TODAY 92-94 / CG 125 TITAN 95-02 / XLR 125 97-01 +4.00 Ø60.50
9020810107	CG 125 TITAN 02-04 / CG 125 FAN 05-08 / NXR 125 BROS 03-05 +2.00 Ø58.50
9020810108	CG 125 TITAN 02-04 / CG 125 FAN 05-08 / NXR 125 BROS 03-05 +3.00 Ø59.50
9020810109	CG 125 TITAN 02-04 / CG 125 FAN 05-08 / NXR 125 BROS 03-05 +4.00 Ø60.50
9020810244	CG 125 TITAN 02-04 / CG 125 FAN 05-08 / NXR BROS 125 03-05 MODIFICADO 150CC STD Ø62.00
9020810245	CG 125 TITAN 02-04 / CG 125 FAN 05-08 / NXR BROS 125 03-05 MODIFICADO 150CC +0.25 Ø62.25
9020810246	CG 125 TITAN 02-04 / CG 125 FAN 05-08 / NXR BROS 125 03-05 MODIFICADO 150CC +0.50 Ø62.50
9020810247	CG 125 TITAN 02-04 / CG 125 FAN 05-08 / NXR BROS 125 03-05 MODIFICADO 150CC +0.75 Ø62.75
9020810248	CG 125 TITAN 02-04 / CG 125 FAN 05-08 / NXR BROS 125 03-05 MODIFICADO 150CC +1.00 Ø63.00
9020810239	CG 125 TODAY 92-94 / CG 125 TITAN 95-02 / XLR 125 97-01 MODIFICADO 150CC STD Ø62.00
9020810240	CG 125 TODAY 92-94 / CG 125 TITAN 95-02 / XLR 125 97-01 MODIFICADO 150CC +0.25 Ø62.25
9020810241	CG 125 TODAY 92-94 / CG 125 TITAN 95-02 / XLR 125 97-01 MODIFICADO 150CC +0.50 Ø62.50
9020810133	CG 150 TITAN 04-08 / CG 150 TITAN FAN 09-15 / NXR 150 BROS 06-15 +2.00 Ø59.30
9020810134	CG 150 TITAN 04-08 / CG 150 TITAN FAN 09-15 / NXR 150 BROS 06-15 +3.00 Ø60.30
9020810135	CG 150 TITAN 04-08 / CG 150 TITAN FAN 09-15 / NXR 150 BROS 06-15 +4.00 Ø61.30
9020810324	CG 150 TITAN 04-08 / CG 150 TITAN FAN 09-15 / NXR 150 BROS 06-15 190 CC STD Ø64.50

9020810325	CG 150 TITAN 04-08 / CG 150 TITAN FAN 09-15 / NXR 150 BROS 06-15 190 CC +0.25 Ø64.75
9020810326	CG 150 TITAN 04-08 / CG 150 TITAN FAN 09-15 / NXR 150 BROS 06-15 190 CC +0.50 Ø65.00
9020810372	CG 160 TITAN/FAN 2016 E.D. +3.0
9020810373	CG 160 TITAN/FAN 2016 E.D. +4.0 Ø61.30
9020810268	CRF 230 2007 E.D. +2.00



YAMAHA

9020810374	YS FAZER 150 2014 E.D / XTZ 150 CROSSER 2015 E.D. / FACTOR 150 2016 E.D. +4.00 Ø61.25
------------	---------------------------------------------------------------------------------------

RETENTOR DE VÁLVULA

Criado para vedar e impedir a passagem de óleo e outros fluidos do cabeçote do motor para a câmara de combustão, o Retentor de Válvulas Vini segue rígidos padrões de qualidade, o que garante um produto com alta durabilidade, resistência e qualidade como das peças originais de fábrica.

DIVERSOS

9020**890075**

CG 160 /NRX BROS 160 /XRE 190/ CG 125i 2016 E.D / CG TITAN 125 02 E.D / CG 150 / NXR BROS 150 / NXR BROS 125 13-15/ BIZ 110i / BIZ 125 / POP 100 / C100 DREAM / BIZ 100 / PCX 150 / POP 110i 2016 E.D / LEAD 110 2010 E.D. / CB 250 TWISTER / CB 300 09-15 / XRE 300 09 E.D / CBX 250 TWISTER 01-08 / XR 250 TORNADO 01-08 / YBR 125 ATÉ 2008 / FACTOR 125 2009 ATÉ 2016 / XTZ 125 / TTR 125 2008 E.D / VIRAGO 250 / FUTURE 125 / / BURGMAN 125 / INTRUDER 125 / YES 125 / XY 50Q / MOBY 50 / STAR 50 / SKY 50 / HYPE 50 / ZIG 50

HONDA

9020**890074**

CG 125 77 - 01 / CARGO/TODAY/ TURUNA/ NX 400 FALCON / SAHARA 350 / CRF 230 /CBX 200 /XL 125/CBX 150/CB 450 DX

KASINSKI

9020**890098**

COMET 150

SHINERAY

9020**890096**

APACHE 150

YAMAHA

9020**890097**

CRYPTON 105 98-05 / CRYPTON 115 2010 E.D.

9020**890089**

FACTOR 150 / FAZER 150 / XTZ 150 CROSSER

9020**890077**

YS 250 FAZER / XTZ 250 LANDER / XTZ 250 TENERÉ / XT 225 / TDM 225

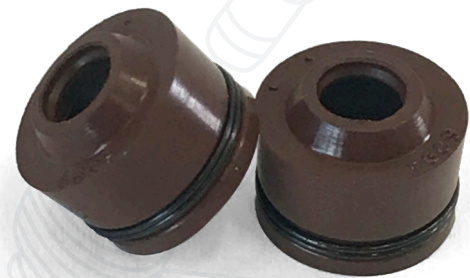

VÁLVULAS

As Válvulas Vini são feitas com materiais que asseguram uma maior vida útil à peça, além de ter sua vedação testada em 100% de capacidade de reter gases e uma menor rugosidade, o que reduz o gotejamento do óleo no cilindro. Todos esses fatores garantem estabilidade ao motor.



DAFRA

9020**890063**

APACHE 150 ADMISSÃO

9020**890064**

APACHE 150 ESCAPE

HONDA

9020**890001**

BIZ 125 2006 E.D. ADMISSÃO

9020**890002**

BIZ 125 2006 E.D. ESCAPE

9020**890013**

CB 300R 2009 E.D. / XRE 300 2009 E.D. / CBX 250 TWISTER 01-08 / XR 250 TORNADO 01-08 ADMISSÃO

9020 890014	CG 300R 2009 E.D. / XRE 300 2009 E.D. / CBX 250 TWISTER 01-08 / XR 250 TORNADO 01-08 ESCAPE
9020 890057	CG 125 FAN 2009 E.D. / NXR 125 BROS 13-15 ADMISSÃO
9020 890058	CG 125 FAN 2009 E.D. / NXR 125 BROS 13-15 ESCAPE
9020 890015	CG 125 ML TURUNA 76-89 / CG 125 TODAY 88-91 ADMISSÃO
9020 890016	CG 125 ML TURUNA 76-89 / CG 125 TODAY 88-91 ESCAPE
9020 890011	CG 125 TITAN 02-04 / CG 125 FAN 05-08 / NXR 125 BROS 03-05 ADMISSÃO
9020 890012	CG 125 TITAN 02-04 / CG 125 FAN 05-08 / NXR 125 BROS 03-05 ESCAPE
9020 890005	CG 125 TODAY 92-94 / CG 125 TITAN 95-01 / XLR 125 97-02 ADMISSÃO
9020 890006	CG 125 TODAY 92-94 / CG 125 TITAN 95-01 / XLR 125 97-02 ESCAPE
9020 890009	CG 150 TITAN FAN 09-14 / NXR 150 BROS 09-14 / CG 150 TITAN 04-08 / NXR 150 BROS 06-08 ADMISSÃO
9020 890010	CG 150 TITAN FAN 09-14 / NXR 150 BROS 09-14 / CG 150 TITAN 04-08 / NXR 150 BROS 06-08 ESCAPE
9020 890083	CG 160 TITAN FAN START 2016 / NXR 160 BROS 2016 ADMISSÃO
9020 890084	CG 160 TITAN FAN START 2016 / NXR 160 BROS 2016 ESCAPE
9020 890003	CRF 230 2008 E.D. / CBX 200 94-02 / NX 200 94-02 / XR 200R 94-02 / BROS 150 03-05 ADMISSÃO
9020 890004	CRF 230 2008 E.D. / CBX 200 94-02 / NX 200 94-02 / XR 200R 94-02 / BROS 150 03-05 ESCAPE
9020 890103	ELITE 125 2019 E.D. ADMISSÃO
9020 890104	ELITE 125 2019 E.D. ESCAPE
9020 890065	LEAD 110 2010 E.D. ADMISSÃO
9020 890066	LEAD 110 2010 E.D. ESCAPE
9020 890099	NX400 99-08 / NX400i 13-15 ADMISSÃO
9020 890100	NX400 99-08 / NX400i 13-15 ESCAPE
9020 890081	PCX 150 2014 E.D. ADMISSÃO
9020 890082	PCX 150 2014 E.D. ESCAPE
9020 890007	POP 100 2007 E.D. / BIZ 100 1998 E.D. / C100 DREAM 92-98 ADMISSÃO
9020 890008	POP 100 2007 E.D. / BIZ 100 1998 E.D. / C100 DREAM 92-98 ESCAPE
9020 890085	POP 110i 2016 / BIZ 110i E.D. ADMISSÃO
9020 890086	POP 110i 2016 / BIZ 110i E.D. ESCAPE
9020 890087	XRE 190 2016 E.D. ADMISSÃO
9020 890088	XRE 190 2016 E.D. ESCAPE

KASINSKI

9020 890061	COMET 150 ADMISSÃO
9020 890062	COMET 150 ESCAPE

SHINERAY

9020 890029	XY 50Q / MOBY 50 / STAR 50 / SKY 50 / HYPE 50 / ZIG 50 ADMISSÃO
9020 890030	XY 50Q / MOBY 50 / STAR 50 / SKY 50 / HYPE 50 / ZIG 50 ESCAPE

SUZUKI

9020 890067	BURGMAN 125 ADMISSÃO
9020 890068	BURGMAN 125 ESCAPE
9020 890101	BURGMAN 125 2011 E.D. ADMISSÃO
9020 890102	BURGMAN 125 2011 E.D. ESCAPE
9020 890051	INTRUDER 125 / YES 125 ADMISSÃO
9020 890052	INTRUDER 125 / YES 125 ESCAPE

YAMAHA

9020 890032	CRYPTON 105 98-05 / CRYPTON 115 2010 E.D. ADMISSÃO
9020 890033	CRYPTON 105 98-05 / CRYPTON 115 2010 E.D. ESCAPE
9020 890017	YBR 125 FACTOR 2000 E.D. / XTZ 125 2003 E.D. / TTR 125 2008 E.D. ADMISSÃO
9020 890018	YBR 125 FACTOR 2000 E.D. / XTZ 125 2003 E.D. / TTR 125 2008 E.D. ESCAPE
9020 890092	YBR FACTOR 125 2017 E.D. ADMISSÃO
9020 890094	YBR FACTOR 125 2017 E.D. ESCAPE
9020 890079	YS 150 FAZER 2014 E.D. / XTZ 150 CROSSER 2014 E.D. ADMISSÃO
9020 890080	YS 150 FAZER 2014 E.D. / XTZ 150 CROSSER 2014 E.D. ESCAPE
9020 890093	YS 250 FAZER 06-15 / XTZ 250 LANDER 07-15 / XTZ 250 TENERE 11-15 (GASOLINA) ADMISSÃO
9020 890095	YS 250 FAZER 06-15 / XTZ 250 LANDER 07-15 / XTZ 250 TENERE 11-15 (GASOLINA) ESCAPE



ORIGINAL
da
Saita

Com **peças de motor Vini**
você vai muito mais longe.



#vádevini



elétrico
e suas partes

ORIGINAL
da
Lata

#VÁDEVINI



PLASTIC

BOX

SEGURANÇA

NO SEU PEDIDO

Vini[®]

by Controlflex[®]



VINI INDUSTRIAL CO., LTD



BOBINA DE IGNIÇÃO HOTPARTS

**MAIS
DURABILIDADE
E QUALIDADE**

9020880576
BOBINA RACING HOT PARTS UNIVERSAL



MOTOR DE PARTIDA

O motor de partida transforma a energia elétrica que recebe da bateria em energia mecânica para girar o motor a combustão e vencer a resistência ao movimento - causada pela compressão dos cilindros, atrito e o peso das peças internas, como pistões, bielas e virabrequim.

HONDA

9020880514	BIZ 125 05-16
9020880516	C100 BIZ ES 98-05 / C100 BIZ+ 98-05 / C105 BIZ ES 98-05
9020880581	CB 300 09-15 / XRE 300 2010 E.D.
9020880518	CBX 250 TWISTER 00-08 / XR 250 TORNADO 01-08
9020880512	CG 125 ES 00-04 / KSE 00-04
9020880517	CG 125 TITAN ES-KSE 00-04 / NXR 125-150 BROS 03-05 / CBX 200 / XR 200 / NX 200 / CBX 150 / NX 150
9020880513	CG 150 TITAN ES-ESD 04-08 / CG 150 TITAN FAN ES-ESD 09-15 / CG 125 FAN ES 09-18 / CG 150 Sport / NXR 150 BROS ES-ESD 06-15 / NXR 125 BROS ES-ESD 13-15
9020880582	CG 160 TITAN FAN 2016 E.D. / NXR 160 BROS 2015 E.D. / XRE 190 2016 E.D.
9020880617	BIZ 125 2011 E.D.

SUZUKI

9020880580	BURGMAN 125i 11-16 / LINDY 125 2017 E.D.
9020880584	INTRUDER 125 02-16 / YES 125 05-11

YAMAHA

9020880515	CRYPTON 98-05
9020880583	XT225 96-06 / TDM225 97-05
9020880585	YS 250 FAZER 2012 E.D. / XTZ 250 LANDER 2013 E.D. / XTZ 250 TENERE 13-19
9020880616	YS 150 FAZER 14-19 / XTZ 150 CROSSER 15-18 / YBR 150 FACTOR 16-19 / YBR FACTOR 125i 17-18
9020880621	YS 250 FAZER 06-10 / XTZ 250 LANDER 07-10
9020880636	CRYPTON 115 09-16

SENSOR DO VELOCÍMETRO

Responsável por transmitir a velocidade da motocicleta até o painel de instrumentos, o sensor de velocidade substitui o conjunto de engrenagem e transmite velocidade da motocicleta até o painel de forma eletrônica.

HONDA

9020780017 XRE 300 2010 E.D.



**QUALIDADE
e
SEGURANÇA
GARANTIDAS**

#vádevini



embreagem

e suas partes

QUEM USA VINI

não quer saber
de outra marca.



CUBO E PLATÔ

HONDA

9020870009	BIZ 100 98-05 / C100 DREAM
9020870017	BIZ 125 2005 E.D.
9020870010	CG 125 TODAS / FAN 125 04 ATÉ 2008 / NXR BROS 125 03-05 / CBX 200 STRADA / XR 200 / NX 200 / XLR 125
9020870112	CG 160 TITAN / FAN / START 2016 E.D. / NXR 160 BROS 2015 E.D.
9020870012	CG 150 TITAN 04-15 / CG 125 FAN 2009 E.D. / NXR 150 BROS 06-15 / NXR BROS 125 03-05
9020870133	CRF230
9020870125	POP 100 07-15
9020870115	POP 110i 2016 E.D. / BIZ 110i 2018 E.D.



YAMAHA

9020870022	YS 250 FAZER 2006 E.D. / XTZ 250 LANDER 07-14 / XTZ 250 TÉNÉRÉ 11-18
9020870011	YBR 125 00-08 / FACTOR 125 09-16 / XTZ 125 03-16 / TTR 125 08-13
9020870131	YS 150 FAZER 2014 E.D. / FACTOR 150 2017 E.D. / XTZ 150 CROSSER 2014 E.D.

DISCO DE EMBREGEM

Os coeficientes estático e dinâmico dos Discos de Embreagem Vini asseguram a estabilidade do arranque e a direção dinâmica necessários para uma boa condução. A cola especial utilizada garante excelente fixação, inclusive em temperaturas de até 300°C.

DAFRA

9020870044	HYPE 50 (3 DISCOS)
9020870004	SPEED 150 08-15 (5 DISCOS)

HONDA

9020870001	BIZ 100 / C100 DREAM / WEB 100 (4 DISCOS)
9020870137	BIZ 110i 16-17
9020870138	BIZ 110i 2018 E.D.
9020870029	BIZ 125 2005 E.D. (4 DISCOS)
9020870024	CB300R 09-15 / XRE 300 2009 E.D. / NX400 FALCON / XR400 1996 / CB400 80-94 / CB450 1994 (7 DISCOS)
9020870003	CBX 200 STRADA 93-03 / NXR 150 BROS 03-05 (5 DISCOS)
9020870002	CBX 250 TWISTER 01-08 / XR250 TORNADO 01-08 (6 DISCOS)
9020870004	CG 160 TITAN FAN START 2016 / NXR 160 BROS 2016 / XRE 190 2017 E.D. / CG 150 FAN 09-15 / CG 125 TODAS / CG 150 TITAN 04-08 / NXR 150 BROS 06-15 / NXR 125 BROS (5 DISCOS)
9020870126	CRF 230 TODOS OS ANOS (6 DISCOS)
9020870116	POP 110i 2016 E.D. (4 DISCOS)

JONNY

9020870044	ZIG 50 (3 DISCOS)
------------	-------------------

KASINSKI

9020870044	SOFT 50 (3 DISCOS)
------------	--------------------

SHINERAY

9020870015	XY50Q / PHOENIX (2 DISCOS)
------------	----------------------------

SUZUKI

9020870103	YES 125 / INTRUDER 125 (5 DISCOS)
------------	-----------------------------------

TRAXX

9020870044	STAR 50 (3 DISCOS)
------------	--------------------

YAMAHA

9020870136	CRYPTON 115 10-16 (2 DISCOS)
9020870005	CRYPTON T105 98-05 (5 DISCOS)
9020870023	XT 225 (6 DISCOS)
9020870006	YBR 125 00-08 / FACTOR 125 09-16 / XTZ 125 03-16 / TTR 125 08-13 (5 DISCOS)
9020870113	YS 150 FAZER 2014 E.D. / FACTOR 150 2017 E.D. / XTZ 150 CROSSER 2014 E.D. / FACTOR 125i 2017 E.D. (4 DISCOS)
9020870026	YS 250 FAZER 2006 E.D. / XTZ 250 LANDER 07-14 / XTZ 250 TÉNÉRÉ 11-19 (6 DISCOS)

EIXO SECUNDÁRIO

Responsável por acoplar as engrenagens do câmbio de transmissão de marchas, o Eixo Secundário Vini possui excelente qualidade, ótima resistência e durabilidade.

HONDA

9020790003 BIZ 100 98 - 05 / C100 DREAM 92-98

9020790050 BIZ 100 13-15

9020790045 BIZ 125 06-17

9020790052 CBX 200 94-02 / NX 200 94-02 / XR 200R 94-02

9020790004 CG / ML / TUR / XLS ATE 91

9020790002 CG 125 FAN 05-08 / TITAN 00-04 / TITAN 92-99 / CG 125 CARGO / CG 125 TODAY

9020790042 CG 150 TITAN ES ESD 04-08

9020790056 CG 160 TITAN / FAN 2016 E.D.

9020790055 NXR 150 BROS 09-13 KS

9020790058 NRX 160 BROS 2015 E.D. / XRE 190 2016 E.D.

9020790057 POP 100 07-15

SUNDOWN

9020790003 WEB 100

SUZUKI

9020790041 YES 125 06-14 / INTRUDER 125

YAMAHA

9020790051 YBR 125 00-07 / XTZ 125 03-07

9020790059 YBR 125 08-16 / XTZ 125 09-15 / TTR 125 2008 E.D.

9020790060 YS 150 FAZER 2014 E.D. / XTZ 150 CROSSER 2015 E.D. / FACTOR 150 2017 E.D.



ORIGINAL
da
Lata

Pioneira absoluta no mercado,
a embalagem metálica da **Vini**
é conhecida e reconhecida pelo
seu **design** diferenciado e por
preservar a integridade e a
qualidade do seu produto.



AFTERMARKET
Controlflex[®]
UMA DIVISÃO CONTROLFLEX GROUP

VINI MOTO PARTS



QUEM USA, NÃO QUER
SABER DE OUTRA!





AFTERMARKET
Controlflex
 UMA DIVISÃO CONTROLFLEX GROUP



#VADEVINI



#VADEVINI

MIRIAMOTO PARTS

ORIGINAL



solto





“
PRESERVA A INTEGRIDADE
E A QUALIDADE DO SEU PRODUTO
”



COLLE

COLENA PAREDE

G O L E N A P A R E D E

ORIGINAL



STAY

EMBREGEM PRIMÁRIA COMPLETA

A Embreagem Completa Vini é composta por todos os componentes responsáveis pelo funcionamento do sistema de embreagem. De ótima qualidade e durabilidade, este kit contribui para a maior vida útil do motor.



HONDA

9020**870035** BIZ 100 / C100 DREAM ATÉ 2001

9020**870036** BIZ 125 2005 E.D.

YAMAHA

9020**870128** CRYPTON 115 10-16

EMBREGEM PESO PRIMÁRIO

HONDA

9020**870032** BIZ 100 / C100 DREAM

9020**870137** BIZ 110i 16-17

9020**870138** BIZ 110i 2018 E.D

9020**870033** BIZ 125 2005 E.D.

YAMAHA

9020**870134** CRYPTON 115 10-16

9020**870055** CRYPTON T105 98-05

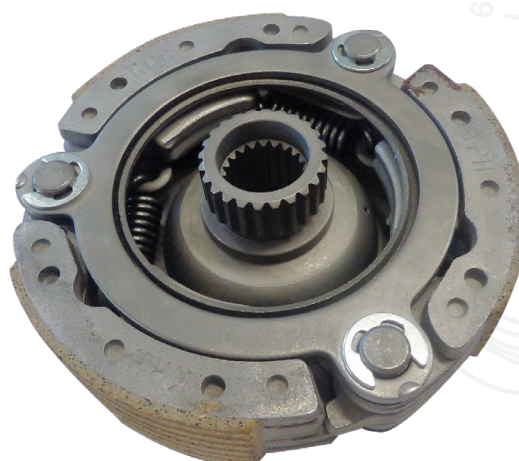

KIT EMBREAGEM

Produzida em alumínio com alto teor de cobre, a Liga do Kit de Embreagem Vini é mais resistente que outras similares. Além de ser desenvolvida com materiais selecionados para proporcionar a máxima segurança e desempenho, proporciona aos pilotos produtos mais resistentes e de alta performance.

DAFRA

9020**870109**

RIVA 150 2011 E.D. / SPEED 150 2008 E.D. / KANSAS 150 2008 E.D. / APACHE 150 2010 E.D.

HONDA

9020**870013**

BIZ 100 / C100 DREAM

9020**870130**

BIZ 110i 2016 E.D.

9020**870084**

BIZ 125 2005 E.D.

9020**870110**

CB300R 09-15 / XRE 300 2010 E.D.

9020**870081**

CBX 250 TWISTER 01-08 / XR250 TORNADO 01-08

9020**870014**

CG 125 TODAS / FAN 125 04 ATÉ 2008 / NXR BROS 125 03-05 / XLR 125

9020**870034**

CG 150 TITAN 04-15 / CG 125 FAN 2009 E.D. / NXR 150 BROS 06-15 / NXR BROS 125 03-05

9020**870117**

CG 160 TITAN / FAN / START 2016 E.D. / NXR 160 BROS 2015 E.D.

9020**870111**

NX 400/400i FALCON

9020**870135**

POP 100 07-15

9020**870121**

POP 110i 2016 E.D.

JONNY

9020**870037**

STAR 50 / HYPE 50 / ZIG 50 / SOFT 50

SHINERAY

9020**870039**

XY50Q / PHOENIX

SUZUKI

9020**870082**

YES 125 / INTRUDER 125 07-13

YAMAHA

9020**870083**

YBR 125 00-08 / FACTOR 125 09-16 / XTZ 125 03-16 / TTR 125 08-13

9020**870120**

YS 150 FAZER 2014 E.D. / FACTOR 150 2017 E.D. / XTZ 150 CROSSER 2014 E.D.

9020**870131**

YS 150 FAZER 2014 E.D. / FACTOR 150 2017 E.D. / XTZ 150 CROSSER 2014 E.D.

9020**870108**

YS 250 FAZER 2006 E.D. / XTZ 250 LANDER 2007 E.D. / XTZ 250 TENERÉ 11-19

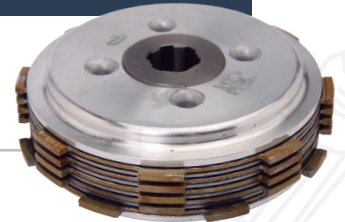

PLACA DE PARTIDA

Fabricado dentro do mais alto padrão de qualidade e segurança, a Placa de Partida Vini garante performance superior. Acionada através de engrenagens em sentido anti-horário, ela funciona por força centrífuga fazendo com que haja o funcionamento dos componentes internos do motor na hora da partida.



DAFRA

9020870063 SPEED 150

HONDA

9020870060 BIZ 100 / C100 DREAM

9020870118 CB 300R 09-15 / XRE 300 2010 E.D.

9020870057 CG 125 TITAN 00-04 / CBX 200 94-02 / NX 200 94-02 / XR 200R 94-02

9020870058 CG 150 TITAN 04-15 / CG 150 FAN 09-15 / NXR 150 BROS 2006 E.D / BIZ 125 / CG 125 / CBX 250/ XR 250 / CRF 230 / CBX 200/ NX 200/ XR 20

9020870127 LEAD 110 10-16

9020870114 XRE 190 2016 E.D.

JONNY

90.20870064 HYPE 50

SHINERAY

9020870064 PHOENIX 50 / JET 50 / XY 50Q

SUZUKI

9020870122 INTRUDER GN 125 / YES 125 / KATANA 125

SUNDOWN

9020870060 WEB 100

TRAXX

9020870064 STAR 50

YAMAHA

9020870124 CRYPTON 10-16

9020870129 NEO AT 115 05-12

9020870062 YBR 125 00-05

9020870061 YBR 125 06-08 / FACTOR 125 09-16 / XT225

9020870123 YS 150 FAZER / XTZ 150 / FACTOR 150 / FACTOR 125 i 2017 E .D. / CRYPTON 105 ATÉ 2005

9020870119 YS 250 FAZER 06-17 / XTZ 250 LANDER 07-18 / XTZ 250 TÉNÉRÉ 11-19

ROLETES CONTRAPESO DE VELOCIDADE

HONDA

9020790063 PCX 150 13-15

9020790062 PCX 150 16-17

YAMAHA

9020790061 NEO 125i 2017 E.D.



SEPARADOR DE DISCO DE EMBREAGEM

Responsável pela separação dos discos de fricção, o Separador de Disco de Embreagem Vini garante o funcionamento correto, evitando danos ao conjunto da embreagem, que funciona por atrito.

DAFRA

9020870018 SPEED 150 2008 E.D / KANSAS 150 2008 E.D / APACHE 150 2010 E.D.

HONDA

9020870105 BIZ 125 2005 E.D.

9020870018 CG 125 TODAS / FAN 125 04 ATÉ 2008 / CBX 200 STRADA / XR 200 / NX 200 / XLR 125

9020870107 CG 160 TITAN FAN START 2016 / NXR 160 BROS 2016 / CG 150 FAN 2009 E.D / NXR 150 BROS 06-15 / CG 125 FAN 2009 E.D / CG 150 TITAN 04-08 / NXR 125 BROS 13-15

9020870019 POP 100 / BIZ 100 / C100 DREAM

YAMAHA

9020870106 YBR 125 00-08 / FACTOR 125 09-16 / XTZ 125 03-16 / TTR 125 08-13

9020870141 YS 150 FAZER 14 E.D / XTZ 150 CROSSER 15 E.D / FACTOR 150 17 E.D / YBR FACTOR 125i 17 E.D





#viniéviciante

chassis
e suas partes



**MAIOR DE
SEM
PE
NHO**

Ótimo acabamento
e tecnologia de ponta

Vini[®]
by Control Flex

AMORTECEDORES

O amortecedor é o responsável por diminuir o impacto no asfalto e garantir a estabilidade da moto enquanto você dirige. Os Amortecedores Vini são produzidos com altos controles de qualidade, assegurando assim um funcionamento mais preciso da moto.

HONDA

9020880599	BIZ 125 2018 E.D. / POP 110i 2016 E.D. PAR / BIZ 110i 2016 E.D. PAR
9020880444	BIZ 125 05-14 / C100 BIZ 98-05 / POP 100 07-14 PAR
9020880600	CB 250 TWISTER 2016 E.D. PEÇA
9020880499	CB 300R 09-15 PEÇA
9020880042	CBX 250 00-08 PEÇA
9020880039	CG 125 83-99 PAR
9020880037	CG 125 TITAN 00-04 / CG 125 FAN 05-08 PAR
9020880038	CG 150 TITAN 04-08 / CG 150 TITAN FAN 09-15 PAR
9020880601	CG 160 TITAN / FAN / START 2016 E.D. PAR
9020880503	NX400 / NX400i FALCON 99-15 PEÇA
9020880043	XR 250 TORNADO 01-08 PEÇA
9020880041	XRE 190 2016 E.D. / NXR BROS 160 2016 E.D. / NXR BROS 125 / 150 03-15 PEÇA
9020880498	XRE 300 2010 E.D. PEÇA

SUZUKI

9020880040	YES 125 05-12 PAR
------------	-------------------

YAMAHA

9020880502	CRYPTON 115 10-16 PAR
9020880500	XTZ 125 03-15 PEÇA
9020880501	XTZ 250 LANDER 07 E.D. / XTZ 250 TENERÉ 11-19 PEÇA
9020880036	YBR 125 00-14 PAR
9020880595	YS 150 FAZER 2014 E.D. / YBR FACTOR 150i 2017 E.D. / YBR FACTOR 125i 2017 E.D. PAR
9020880504	YS 250 FAZER 05-17 PEÇA

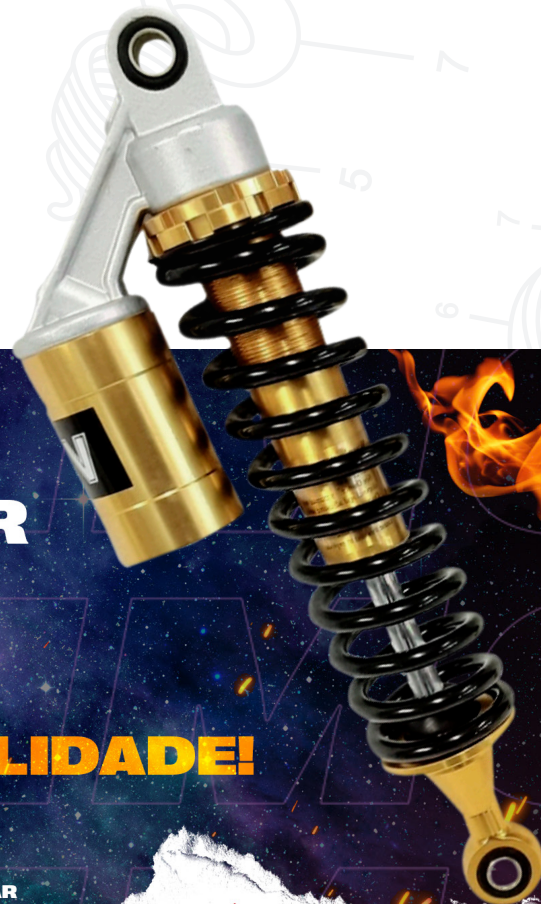

Vini
HOT PARTS

AMORTECEDOR UNIVERSAL HOTPARTS

MENOS MAIS IMPACTO DURABILIDADE!

- 9020880574 UNIVERSAL AZUL (RACING PARTS) ATÉ 200CC PAR
- 9020880575 UNIVERSAL DOURADO (RACING PARTS) ATÉ 200CC PAR
- 9020880573 UNIVERSAL VERDE (RACING PARTS) ATÉ 200CC PAR
- 9020880572 UNIVERSAL VERMELHO (RACING PARTS) ATÉ 200CC PAR

Vini
by Controlflex

CAIXA DE DIREÇÃO

Com a função de converter a rotação do guidão em movimento horizontal para esquerda e para direita, sendo transmitido às rodas, a Caixa de Direção da Vini é garantia de firmeza no movimento da motocicleta.

HONDA

9020880179	BIZ 100 / POP 100 / POP 110i / BIZ 125 / PCX 150 / SOFT 50 (COM COLAR)
9020880479	CB 300R 10-15 / CBX250 TWISTER 01-08 / CB TWISTER 250 2016 E.D. / CB-300 09-15 / CBR 450 / 600 / 900 / 1000 / CB500 97-05 / HORNET 600 / VT 600 SHADOW (COM COLAR)
9020880180	CG 125 77-99 (COM COLAR)
9020880064	CG 160 TITAN-FAN 2016 E.D. / CG 125 TITAN 00-04 / CG 125 FAN 05-18 / CG 150 TITAN-FAN (COM COLAR)
9020880481	LEAD 110 09-15 (COM COLAR)
9020880063	NXR 160 BROS 2016 E.D. / NXR BROS 150 03-14 / NXR 125 BROS 03-15 / XRE 300 2010 E.D. / XRE 190 2016 E.D. / NX4 FALCON 99-15 / CRF230 / XR 250 TORNADO 01-08 / XR 200 94-03 / XL 200 82-84 / XLX 250 87-93 (COM COLAR)

KASINSKI

9020880179	SOFT 50 (ESFERAS)
------------	-------------------

KAWASAKI

9020880482	KDX 200 / 220 / KLX 250 / S / SF / KLX 300R (COM COLAR)
------------	---------------------------------------------------------

SHINERAY

9020880180	XY50Q (COM COLAR)
------------	-------------------

SUNDOWN

9020880179	WEB 100 (ESFERAS)
9020880482	STX 200 (COM COLAR)

SUZUKI

9020880596	BURGMAN 125 05-10 (COM COLAR)
9020880482	BURGMAN 400 / INTRUDER 250 / BANDIT 650 / 650S / 1200 / GSF 600 / 1200 (COM COLAR)
9020880566	YES 125 / KATANA 125 / INTRUDER 125 / GSR 150i / SPEED 150 09-15 (COM COLAR)



TRAXX

9020880399	STAR 50 (COM COLAR)
------------	---------------------

YAMAHA

9020880497	XTZ 125 2003 E.D. / TTR 125 2008 E.D. (COM COLAR)
9020880136	YBR 125 FACTOR 09-16 / VIRAGO 250 95-02 (COM COLAR)
9020880508	YBR 125 00-08 / CRYPTON T105 98-05 / CRYPTON 115 2010 E.D. / DT 180 / RD 125 / RD 135 / RDZ 125 / RS 125 / RX 80 / RX 180 (COM COLAR)
9020880565	YS 150 FAZER 2014 E.D. / YBR FACTOR 125i 2017 E.D. / YBR FACTOR 150i 2017 E.D. (COM COLAR)
9020880482	YS 250 FAZER / XTZ 250-750 / XJ6 / RD 350 / XT 350 / 600 / 600E / 660R / TDM 850 (COM COLAR)



CILINDRO DE BENGALA

Como parte da suspensão dianteira, o Cilindro Vini garante a estabilidade necessária nas motocicletas. Isso tudo com 100% de garantia e o melhor desempenho.

HONDA

9020880483	BIZ 125 06-11
9020880490	BIZ 125 2011 E.D.
9020880539	CB 250 TWISTER 2016 E.D.
9020880101	CB 300R 09-15 / CBX 250 TWISTER 01-08
9020880102	CBX 200 STRADA
9020880103	CG 125 TODAY TITAN 95-04 / CG 125 FAN 05-08
9020880100	CG 150 TITAN / FAN / CG 160 TITAN / FAN / START 16-17 / CG 160 TITAN / FAN / START 2018 E.D.
9020880558	CG 160 TITAN / FAN LADO DIREITO 2018 E.D.
9020880535	CRF 230
9020880536	LEAD 110 10-15
9020880485	NX 400 / NX400i FALCON 99-15
9020880099	NXR 125 BROS 03-04 / NXR 150 BROS 03-05
9020880477	NXR 160 BROS 2016 E.D. / NXR 150 BROS 06-15 / NXR 125 BROS 13-15
9020880557	PCX 150 2014 E.D.
9020880098	POP 110i 2016 E.D. / POP 100 07-15 / C100 DREAM 92-98 / BIZ 100 99-05
9020880097	XLR 125
9020880484	XR 250 TORNADO 01-08
9020880489	XRE 300 2010 E.D.

SHINERAY

9020880186	PHOENIX
------------	---------

SUZUKI

9020880532	INTRUDER 125 03-15
9020880104	YES 125



YAMAHA

9020880487	CRYPTON 105 98-05
9020880488	CRYPTON 115 2010 E.D.
9020880537	NEO 115 05-12
9020880486	XTZ 125 03-15
9020880533	XTZ 150 CROSSER 2015 E.D.
9020880556	XTZ LANDER 250 07-14
9020880096	YBR 125 00-08 / YBR FACTOR 125 / 150 09 E.D. / YS 150 FAZER 2014 E.D.
9020880538	YS 250 FAZER 06-11
9020880510	YS 250 FAZER 12-17

CILINDRO DE FREIO

O cilindro de freio dianteiro e traseiro em uma motocicleta desempenha um papel crucial no sistema de freio. Ele é responsável por transferir a força aplicada pelo piloto no manete e no pedal de freio, gerando a pressão hidráulica necessária para acionar as pinças de freio nas rodas dianteiras e traseiras, proporcionando uma frenagem segura e adequada à motocicleta.

HONDA

9020880622	BIZ 125 06-ED (DIANTEIRO)
9020880629	CG 125 TITAN 00-04 ESD (DIANTEIRO)
9020880627	CG 150 TITAN 04-13 ESD (DIANTEIRO)
9020880623	NXR 150 BROS 03-15 (DIANTEIRO)
9020880631	CG 150 TITAN 15-ED / TITAN 160 EX 16-ED (TRASEIRO)
9020880625	NXR 160 BROS EDD 15-20 / XRE 190 16-20 (TRASEIRO)

YAMAHA

9020880632	YBR 125 00-08 (DIANTEIRO)
9020880634	YBR 125 FACTOR 09 - ED (DIANTEIRO)

CORREIA DE TRANSMISSÃO

Correias são discos de fricção e dependem do atrito entre a correia e a polia, que são itens cilíndricos que se movimentam pela rotação do eixo do motor e também pelas correias, para transmitir energia.

DAFRA

9020800068	FUTURE 125 05-14 / LASER 150 08-10
9020800073	SMART 125 09-14

HONDA

9020800087	ELITE 125 2019 E.D.
9020800069	LEAD 110
9020800085	PCX 150

SUZUKI

9020800070	BURGMAN 125 07-10
------------	-------------------

YAMAHA

9020800084	NEO 115
9020800086	N-MAX 160



ENGRENAGEM DO VELOCÍMETRO

Responsável por transmitir a velocidade do veículo ao painel de instrumentos, o Conjunto do Velocímetro Vini é produzido com materiais extremamente resistentes, que garantem a segurança na pilotagem, além do belo design. Além disso, são realizados diversos testes de qualidade e segurança, que comprovam a ótima durabilidade e resistência da peça a diversos tipos de situações.

HONDA



9020**880221**

CBX 250 TWISTER 00-08 / CB 400- 450 / CB 500



9020**880335**

CG 125 FAN 04-08 / CG 125 TITAN KS 00-04 / C100 DREAM 92-98 / BIZ 100 98-05



9020**880224**

CG 125 TITAN 00 ES / CBX 150 / CBX 200 STRADA



9020**880528**

CG 125 TITAN 95-99 (DE FERRO)



9020**880223**

CG 150 KS 04-08 / CG 125 FAN KS 09-18 / BIZ 125 06-15 / POP 100 07-15



9020**880386**

CG 150 TITAN ESD 04-08 / CG 150 TITAN FAN ESD 09-15

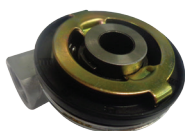

9020**880219**

NXR 125 / 150 BROS 03-15



9020**880334**

NXR 150 BROS 06-15 / NXR 125 03-05 / XLX 250R 87-94



9020**880220**

XR 250 TORNADO 02-08 / NX 400 / 400i FALCON 99-15

TRAXX



9020**880333**

STAR 50



9020**880387**

XTZ 125 / XT 225 / 600 / XTZ 225 04-07 / DT 200



9020**880225**

YBR 125 ED 00-08



9020**880388**

YBR 125 FACTOR ED 09-16



9020**880222**

YBR FACTOR 125 2009 E.D. / YBR 125 00-08

FLEXÍVEL DE FREIO

DIVERSOS

9020**930008** BIZ 125 + / CBX 250 TWISTER / YS 250 FAZER / YS 125 (DIANTEIRO)

HONDA

9020**930018** CB 300R 10-15 (DIANTEIRO)

9020**930001** CG 125 FAN 2014 E.D. / CG150 FAN 2011 E.D. / CG 150 TITAN 2011 E.D. / CG 150 TITAN ESD 2004 E.D. / CG 150 TITAN MIX 09-10 / CG160 TITAN FAN 2016 E.D. (DIANTEIRO)

9020**930016** CG 125 TITAN 00-04 / CG 125 FAN 05-08 (DIANTEIRO)

9020**930006** CRF 230F (DIANTEIRO)

9020**930012** NX4 FALCON 00-08 (DIANTEIRO)

9020**930004** NXR BROS 150 2006 E.D. (DIANTEIRO)

9020**930014** XR 250 TORNADO 03-08 (DIANTEIRO)

9020**930005** XRE 300 2010 E.D. (DIANTEIRO)

YAMAHA



9020**930007** XTZ 125 03-15 / NX4 FALCON 00-08 (DIANTEIRO)

9020**930013** XTZ 150 CROSSER / XTZ 250 TENERE (DIANTEIRO)

9020**930011** XTZ 250 LANDER 06-17 (DIANTEIRO)

9020**930019** XTZ 250 LANDER 06-17 (TRASEIRO)

9020**930017** YBR 125 / FACTOR 125 (DIANTEIRO)

**DURABILIDADE
e
RESISTÊNCIA**

PAINEL

A Vini possui os mais diversos tipos de painéis, analógicos e digitais, com qualidade, desempenho e garantia. Tudo isso com o melhor custo-benefício do mercado e mais de 20 aplicações diferentes.

HONDA



9020**880526**

BIZ 100 13-15



9020**880545**

BIZ 110i 2016 E.D.



9020**880243**

BIZ 125 05-08



9020**880240**

CBX 250 TWISTER 01-08



9020**880234**

CG 125 TITAN 94-99 / TODAY 125 88-94



9020**880235**

CG 125 TITAN 00-04



9020**880554**

CG 150 FAN 11-13



9020**880239**

CG 150 TITAN ES ESD 04-08



9020**880245**

CG 150 TITAN ESD 09-10 AZUL



9020**880238**

CG 150 TITAN KS 04-08



9020**880244**

CG 150 TITAN KS/ES 09-10 AZUL



9020**880551**

FAN 125 05-06



9020**880552**

FAN 125 07-08



9020**880553**

FAN 125 09-13



9020**880247**

NXR 125 BROSS 03-05 / NXR 150 BROS 03-05



9020**880527**

NXR 150 BROS 06-08



9020**880548**

NXR 150 BROS 09-10



9020**880549**

NXR 150 BROS 10-11



9020**880550**

NXR 150 BROS 12-15



9020**880546**

POP 100 07-15



9020**880547**

POP 110i 2016 E.D.



9020**880248**

XLR 125 96-02

SHINERAY



9020**880147**

XY 50Q-2 - 50 KM

SUZUKI



9020**880242**

INTRUDER 125



9020**880241**

YES 125 06-14

YAMAHA



9020**880555**

XTZ 125



9020**880236**

YBR 125 04-05



9020**880491**

YBR 125 FACTOR 08-13

PEDAL DE CÂMBIO

◆ Produzido nos mais altos padrões de qualidade e com durabilidade similar ao original, o pedal de câmbio é uma peça ligada a um eixo seletor, responsável pela troca de marchas.

HONDA



9020**880314**

BIZ 100 ES / DREAM ATÉ 2005



9020**880315**

BIZ 100 KS / DREAM ATÉ 2005



9020**880598**

BIZ 110i 2016 E.D. / POP 110i 2016 E.D.



9020**880311**

BIZ 125 05-10



9020**880597**

BIZ 125 2011 E.D.



9020**880509**

CB 300 09-15 / CBX 250 01-08 / CBX 200



9020**880024**

CB 300 09-15 / CBX 250 01-08 / CBX 200 (PRETO)



9020**880094**

CG 125 ML / TUR 76-99



9020**880026**

CG TITAN 150 (CROMADO)



9020**880577**

CRF 230



9020**880312**

NX 400 / NX 400i FALCON 99-15



9020**880095**

NXR 125 / 150 BROS 03-14 (NIQUELADO)



9020**880530**

POP 100 07-10



9020**880559**

POP 100 11-15



9020**880093**

XR 250 TORNADO 01-08



9020**880313**

XRE 300 2010 E.D.

SHINERAY



90.20**880202**

PHOENIX



90.20**880115**

XY 50Q

YAMAHA



9020**880028**

XTZ 125 (PRETO)



9020**880074**

YBR 125 (CROMADO)



9020**880531**

YBR 125 FACTOR 11-16



PEDAL DE FREIO

O sistema de freio é composto por uma série de itens que trabalham em conjunto para desacelerar e parar completamente a motocicleta.

HONDA



9020**880321**

NX 400 / 400i FALCON 99 -15



9020**880322**

NXR 150 BROS 2003



9020**880318**

XR 250

PEDAL DE PARTIDA

Devido aos materiais utilizados em sua fabricação, o Pedal de Partida Vini oferece maior conforto na partida do motor e resistência mecânica, além de proteção contra corrosão da superfície. As molas e esfera de aço garantem um posicionamento preciso, enquanto a estria do pedal, formada por brochamento, assegura perfeita montagem com o eixo de partida.

DAFRA



9020**880476**

RIVA 150 2011 E.D.

HONDA



9020**880330**

BIZ 125 06-12 / BIZ 100 13-15



9020**880002**

C100 DREAM 92-98 / BIZ 100 98-05 / POP 100 07-15



9020**880003**

CG 125 83-99



9020**880001**

CG 125 TITAN 00-04 / FAN KS 05-08 / NXR 125 BROS 03-05



9020**880336**

CG 150 TITAN KS 09-10



9020**880004**

CG 150 TITAN KS 05-08 / NXR 150 BROS 06-14



9020**880578**

POP110i 16-18

SHINERAY



9020880205

PHOENIX



9020880114

XY50Q / ZIG 50



9020880329

BURGMAN 125 05-18

YAMAHA



9020880005

DT 180



9020880006

YBR 125 00-16

PINÇA DE FREIO

Projetada para aplicar precisamente a pressão necessária às pastilhas de freio, esta peça crucial é responsável por garantir uma frenagem confiável e segura. Com padrões rigorosos de engenharia OEM, nossa pinça de freio é projetada para atender e exceder os requisitos de segurança e eficácia do sistema de frenagem da sua motocicleta.

HONDA



9020880628

CG 125 TITAN 00-04



9020880630

CG 150 TITAN 09-15



9020880624

NXR 150 BROS ESD 03-15



9020880626

NXR 160 BROS 15-E.D / XRE190 16-E.D

YAMAHA



9020880633

YBR 125 00-08



9020880635

YBR 125 FACTOR 09-13

RAIO E NIPLE

Resistentes e com alta durabilidade, os raios e niples da Vini são cromados, por isso não enferrujam. Além de contar com a melhor relação custo-benefício do mercado.

HONDA

9020880139	BIZ 100 / BIZ 110i / BIZ 125 / BIZ 125i (DIANTEIRO - FREIO A LONA - REFORÇADO E CROMADO)
9020880138	BIZ 100 / BIZ110i / BIZ 125 / POP 100 / POP110i (TRASEIRO - REFORÇADO E CROMADO)
9020880602	BIZ 100 98-14 / BIZ 125 05-14 / POP 100 07-14 (REFORÇADO E CROMADO)
9020880449	BIZ 100 98-14 / BIZ 125 05-14 / POP 100 07-14 (REFORÇADO E CROMADO)
9020880126	FREIO A DISCO REFORÇADO CROMADO CG 125 TITAN- FAN ESD 00-08 /CG 150 TITAN-FAN ESD / CG 160 ESD
9020880124	CG 125 TITAN-FAN KS ES 00-08 / CG 150 TITAN-FAN KS ES / CG 160 KS 16 -E.D. (FREIO A LONA - REFORÇADO E CROMADO)
9020880121	CG 125 TODAY 90-94 / CG 125 TITAN 95-99 / XL 125 87-95 (TRASEIRO - REFORÇADO E CROMADO)
9020880123	CG TITAN 83-88 / CG 125 TITAN CARGO / CG TITAN 79-99 / CG 125 ML / TURUNA CG 125 (REFORÇADO E CROMADO)
9020880142	NX 400 / 400i FALCON 99-15 (REFORÇADO E CROMADO)
9020880143	NX 400 / 400i FALCON 99-15 (REFORÇADO E CROMADO)
9020880460	NXR 125 BROS 03-14 / NXR 150 BROS 03-14 (REFORÇADO E CROMADO C/ ROSCA ORIGINAL)
9020880511	XL 250 82-84/ NX 200 93-01/ XR 200 94-03 (REFORÇADO E CROMADO)
9020880505	XR 250 TORNADO 02-08 (TRASEIRO - REFORÇADO E CROMADO)
9020880506	XRE 300 2010 E.D. (REFORÇADO E CROMADO)
9020880507	XRE 300 2010 E.D. (REFORÇADO E CROMADO)

YAMAHA

9020880464	XTZ 250 LANDER 2007 E.D. / XTZ 250 TENERE 11-19 CROMADO REFORÇADO
9020880456	XTZ CROSSER 150 2015 E.D. / XTZ 125 03-14 / XTZ 250 LANDER 2007 E.D. / XTZ 250 TENERÉ 11-19 (REFORÇADO E CROMADO C/ ROSCA ORIGINAL)
9020880122	YBR 125 00-08 / FACTOR 125 09 E.D. / RD 135 90-00 / RDZ 135 90-92 (DIANTEIRO PARA FREIO A DISCO - REFORÇADO E CROMADO)
9020880120	YBR 125 00-08 / YBR FACTOR 125 09 E.D. / RD 125 90-00 / RDZ 135 90-92 (TRASEIRO E DIANTEIRO PARA FREIO A LONA - REFORÇADO E CROMADO)



TORNEIRA DE COMBUSTÍVEL

Responsável pela passagem de combustível do tanque para os sistema de alimentação da motocicleta (carburador), a torneira de combustível Vini é produzida com material de primeira qualidade, seguindo os padrões de construção da motocicleta.

HONDA

9020880030	CBX 200
9020880031	CBX 250 00-08
9020880035	CG 125 83-88 / CG 125 TODAY 89-94 / CG 125 TITAN 94-99 / CG 125 TITAN KS-ES-KSE 00-04 / CG FAN 125 04-08
9020880032	CG 125 ML / TUR - ATÉ 82
9020880033	CG 150 04-08
9020880564	NX / XR / XLR 125 05-08
9020880561	POP 100 07-15

SUZUKI

9020880563	YES 125 05-12
------------	---------------

YAMAHA

9020880562	CRYPTON 98-05
9020880034	YBR 125 00-16



**DURABILIDADE
e
RESISTÊNCIA**

SEGURANÇA E QUALIDADE DOS ORIGINALS

Control flex[®]
Cabos Tmais

Control flex[®]
Cabos Tmais

 DESENVOLVIDO
NO BRASIL

CABO DE ACELERADOR



HONDA

9020 830115	BIZ 125 05-08
9020 830119	BIZ 125 I.E. 09-10
9020 830215	BIZ 125 KS/ES/EX 2011 E.D.
9020 830070	C100 BIZ 98-05
9020 830143	CB 300R EE 09-15 / CB 300R RA 13-15 (A)
9020 830144	CB 300R EE 09-15 / CB 300R RA 13-15 (B)
9020 830147	CB 300R RA 09-12 (A)
9020 830148	CB 300R RA 09-12 (B)
9020 830032	CBX 200 STRADA 98-02 (A)
9020 830007	CBX 200 STRADA 98-02 (B)
9020 830041	CBX 250 TWISTER 00-08 (A)
9020 830141	XRE 300 / XRE 300 ABS 10-15 (B)
9020 830042	CBX 250 TWISTER 00-08 (B)
9020 830031	CG 125 / ML 125 ATÉ 82
9020 830004	CG 125 83/87 ML 125 83/84 EC00
9020 830129	CG 125 FAN KS-ES-CARGO 09-13
9020 830017	CG 125 TITAN 2000/2001-KS/ES
9020 830023	CG 125 TITAN ES/KS/KSE/CARGO 02-08 / CG 125 FAN 05-08
9020 830005	CG 125 TODAY / CARGO 91 E.D. / CG 125 TITAN ATÉ 99
9020 830217	CG 150 FAN 10-13
9020 830134	CG 150 SPORT 05-08
9020 830045	CG 150 TITAN ES/KS/ESD ATÉ 2008 / CG 150 TITAN JOB ATÉ 2008

9020 830253	CG 150 TITAN ESD-EX 2014 E.D. / CG 150 FAN ESDI 2014 E.D. / CG 150 FAN ESD CARGO 2014 E.D. / CG 150 START ES 2015 E.D. (A)
9020 830254	CG 150 TITAN ESD-EX 2014 E.D. / CG 150 FAN ESDI 2014 E.D. / CG 150 FAN ESD CARGO 2014 E.D. / CG 150 START ES 2015 E.D. / CG 160 TITAN/FAN ESDI-EX 2016 E.D. (B)
9020 830126	CG 150 TITAN MIX 09-10
9020 830214	CRF 230F 2003 E.D. - STREET (A)
9020 830211	CRF 230F 2003 E.D. - STREET (B)
9020 830197	NX4 FALCON 00-12 (A)
9020 830167	NX4 FALCON 00-12 (B)
9020 830043	NXR 125 KS BROS 03-05
9020 830149	NXR 150 BROS ES/KS/ESD ATÉ 08
9020 830133	NXR 150 BROS KS/ES/ESD 2009 E.D.
9020 830122	POP 100 07-12
9020 830273	POP 100 13-15
9020 830034	XLR 125
9020 830033	XR 200R (A)
9020 830058	XR 250 TORNADO 01-08 (A)
9020 830162	XR 250 TORNADO 01-08 (B)
9020 830338	XRE 190 2016 E.D. (A)
9020 830339	XRE 190 2016 E.D. (B)
9020 830140	XRE 300 / XRE 300 ABS 10-15 (A)
9020 830141	XRE 300 / XRE 300 ABS 10-15 (B)
9020 830340	XRE 300 / XREA 300 2016 E.D. (A)
9020 830341	XRE 300 / XREA 300 2016 E.D. (B)



KASINSKI

9020**830252** COMET 250 GTR INJETADA



SHINERAY

9020**830270** REV 250

9020**830110** XY 50-Q

SUNDOWN

9020**830086** HUNTER 90CC

9020**830077** MAX SE - SED / HUNTER

9020**830070** WEB 100

SUZUKI

9020**830106** BURGMAN AN 125 05-10

9020**830100** INTRUDER 125 02-05

9020**830103** YES 125 05-07 / INTRUDER 125 06-16

9020**830175** YES EN 125 08-10 / INTRUDER GN 125 08-10

YAMAHA

9020**830190** NEO 115 05-08 (A)

9020**830351** XT 225 / TDM 225

9020**830352** XT 660R 05-11 (A)

9020**830353** XT 660R 05-11 (B)

9020**830192** XTZ 125 E-K 08-14 / XTZ 125 XE 08-14

9020**830195** XTZ 250 LANDER 07-15 / XTZ 250X 2008 E.D. / XTZ 250 LANDER BLUE FLEX 2016

9020**830059** YBR 125 ED/E-K 02-08

9020**830064** YBR 125 E-K 00-02

9020**830154** YBR 125 FACTOR ED/E-K 09-12

9020**830177** YS 250 FAZER 06-15 (A)

9020**830178** YS 250 FAZER 06-15 (B)

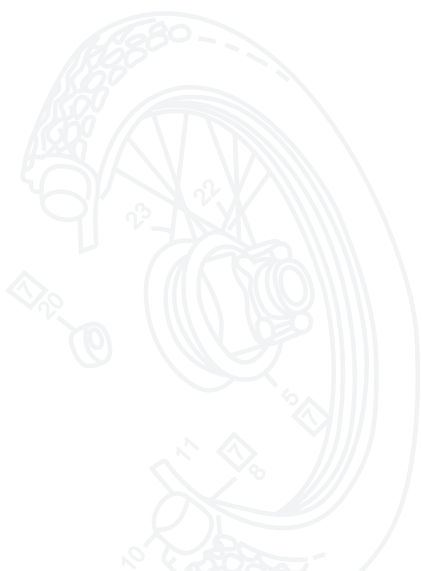

CABO DE AFOGADOR

HONDA

9020830118	BIZ 125 06-10
9020830205	CBX 200 STRADA 98-02
9020830201	CBX 250 TWISTER 00-08
9020830257	CG 150 TITAN SPORT 05-08
9020830198	NX4 FALCON 99-08

KASINSKI

9020830225	SOFT / WIN 110
------------	----------------



CABO DE CONTAGIRO

CABO DE EMBREGEM

DAFRA

9020**830266** APACHE 150

9020**830093** KANSAS 150

9020**830269** SPEED 150

HONDA

9020**830164** CB 300R 09-15

9020**830006** CBX 200 STRADA 98-02

9020**830040** CBX 250 TWISTER 00-08

9020**830001** CG 125 83-87 ML 83 E.D.

9020**830130** CG 125 FAN KS-ES-CARGO 09-13

9020**830009** CG 125 TITAN / TODAY CARGO 91-99

9020**830022** CG 125 TITAN KS-ES-KSE-CARGO 03-04 / CG 125 FAN ATÉ 2008

9020**830030** CG 125/ML ATÉ 82

9020**830206** CG 150 SPORT 05-08

9020**830258** CG 150 TITAN ESD-EX 2014 E.D. / CG 150 FAN ESDI 2014 E.D. / CG 150 FAN ESD CARGO 2014 E.D. / CG 150 START ES 2015 E.D. / CG 160 FAN ESDI 2016 E.D. / CG 160 TITAN EX 2016 E.D. / CG 160 CARGO 2016 E.D. / CG 160 START 2016 E.D.

9020**830127** CG 150 TITAN MIX 09-10

9020**830018** CG 125 TITAN KS/ES 2000

9020**830026** CG 150 TITAN ES/ESD ATÉ 2008 / CG 150 TITAN JOB ATÉ 2008/ CG 150 FAN ESI 2010

SUZUKI

9020**830102** INTRUDER 125

9020**830104** YES 125 / KATANA 125



9020**830210** CRF 230F 2003 E.D. STREET

9020**830161** NX4 FALCON 00-08

9020**830025** NXR 125 KS BROS 03-05

9020**830048** NXR 150 BROS 03-05

9020**830052** NXR 150 BROS KS-ES-ESD 2006 E.D.

9020**830120** POP 100 07-12

9020**830002** XL 125-S

9020**830016** XLR 125

9020**830008** XR 200R

9020**830038** XR 250 TORNADO 01-05

9020**830139** XRE 300 / XRE 300 ABS 2010 E.D.

SHINERAY

9020**830111** XY 50-Q

SUNDOWN

9020**830194** HUNTER 90CC

9020**830067** MAX SE - SED / HUNTER

SUZUKI

9020**830101** INTRUDER 125 02-05

9020**830066** YES 125 05-07

9020**830174** YES 125 EN

YAMAHA

9020**830060** XTZ 125 03/08-XTZ 125X 08-11

9020**830191** XTZ 125 E-K 08-14 / XTZ 125 XE 08-14

9020**830196** XTZ 250 LANDER 07-15 / XTZ 250X 2008 E.D.

9020**830051** YBR 125 ED/E-K 00-08

9020**830156** YBR 125 FACTOR 09-16

9020**830259** YS 150 FAZER 10-15

9020**830179** YS 250 FAZER 06-17



foi desenvolvida a fim
de proporcionar ao mercado
a melhor relação custo-benefício,
com preço competitivo,
qualidade e garantia Controlflex.

CABO DE FREIO



HONDA

9020 830117	BIZ 125i 09-10
9020 830055	BIZ 125 KS-ES-EX 2005 E.D. / BIZ 100 2005 E.D. / BIZ 110i 16-18
9020 830131	CG 125 FAN KS-ES-CARGO 09-13
9020 830024	CG 125 TITAN ES/KS/KSE/CARGO 03-08 / CG 125 FAN 05-08
9020 830027	CG 125 TITAN/CARGO ATÉ 97
9020 830029	CG 125 TITAN / CARGO 98-99
9020 830019	CG 125 TITAN KS 00-02
9020 830219	CG 150 FAN ESI 2010
9020 830124	CG 150 TITAN MIX 09-10
9020 830046	CG 150 TITAN ES/KS ATÉ 2008 / CG 150 TITAN JOB ATÉ 2008
9020 830044	NXR 125 KS BROS 03-05
9020 830209	NXR 150 BROS ES-KS 2006 E.D. / NXR 125 BROS ES-KS 2013 E.D. / NXR 160 BROS ES 2015 E.D.
9020 830121	POP 100 07-12
9020 830274	POP 100 13-15 / POP 110i 2016 E.D.
9020 830054	XLR 125-SATÉ 91

SUZUKI

9020**830107** BURGMAN AN 125 05-10

YAMAHA

9020**830182** NEO 05-12

9020**830063** YBR 125 00-08

9020**830155** YBR 125 FACTOR E/K/K1 09-16



**CABOS
TESTADOS**
em laboratório
de ensaio
dinâmico

CABO DE VELOCÍMETRO

DAFRA

9020**830268** KANSAS 150

HONDA

9020**830049** BIZ 125 05-12 / BIZ 100 ES/KS 13-15 (TAMBOR)

9020**830116** BIZ 125i 2009 E.D. (FREIO A DISCO)

9020**830015** C100 BIZ 98-05

9020**830146** C100 DREAM

9020**830013** CBX 200 STRADA 98-02 / CBX 150 AERO

9020**830021** CBX 250 TWISTER 00-08

9020**830011** CG 125 TITAN ATÉ 99

9020**830014** CG 125 TITAN KS-CARGO 00-04 / CG 125 FAN 2008 / NXR 125 BROS ES-KS 03-05 / NXR 150 BROS KS - ES 2006 E.D. / NX 200 / XLR 125 / NX4 FALCON / XR 250 TORNADO

9020**830047** CG 150 TITAN KS-ES-ESD 05-08 / CG 125 FAN ES-KS-CARGO 2009 E.D.

9020**830125** CG 150 TITAN MIX 09-10

9020**830037** CG TITAN ES-KSE 00-04

9020**830142** LEAD 110 09-15

9020**830012** NX 150/XR 200

9020**830056** NXR 150 BROS ESD 03-05

9020**830145** NXR 150 BROS ESD 06-14

9020**830123** POP 100 07-12

SUNDOWN

9020**830088** MAX SED 2008

SUZUKI

9020**830105** BURGMAN AN 125

9020**830099** INTRUDER 125

9020**830065** YES 125 / KATANA 125

TRAXX

9020**830113** STAR 50

YAMAHA

9020**830181** NEO AT 115 08-12

9020**830061** XTZ 125 / YBR 125 ED 02-08

9020**830180** YBR 125 00-01

9020**830050** YBR 125 E-K 00-08 / YBR 125 FACTOR E-K 09-15 / YBR 125 FACTOR K1 14-15



QUER SABER MAIS?

Acesse nossas
plataformas digitais e
**fique por dentro de
nossas novidades!**

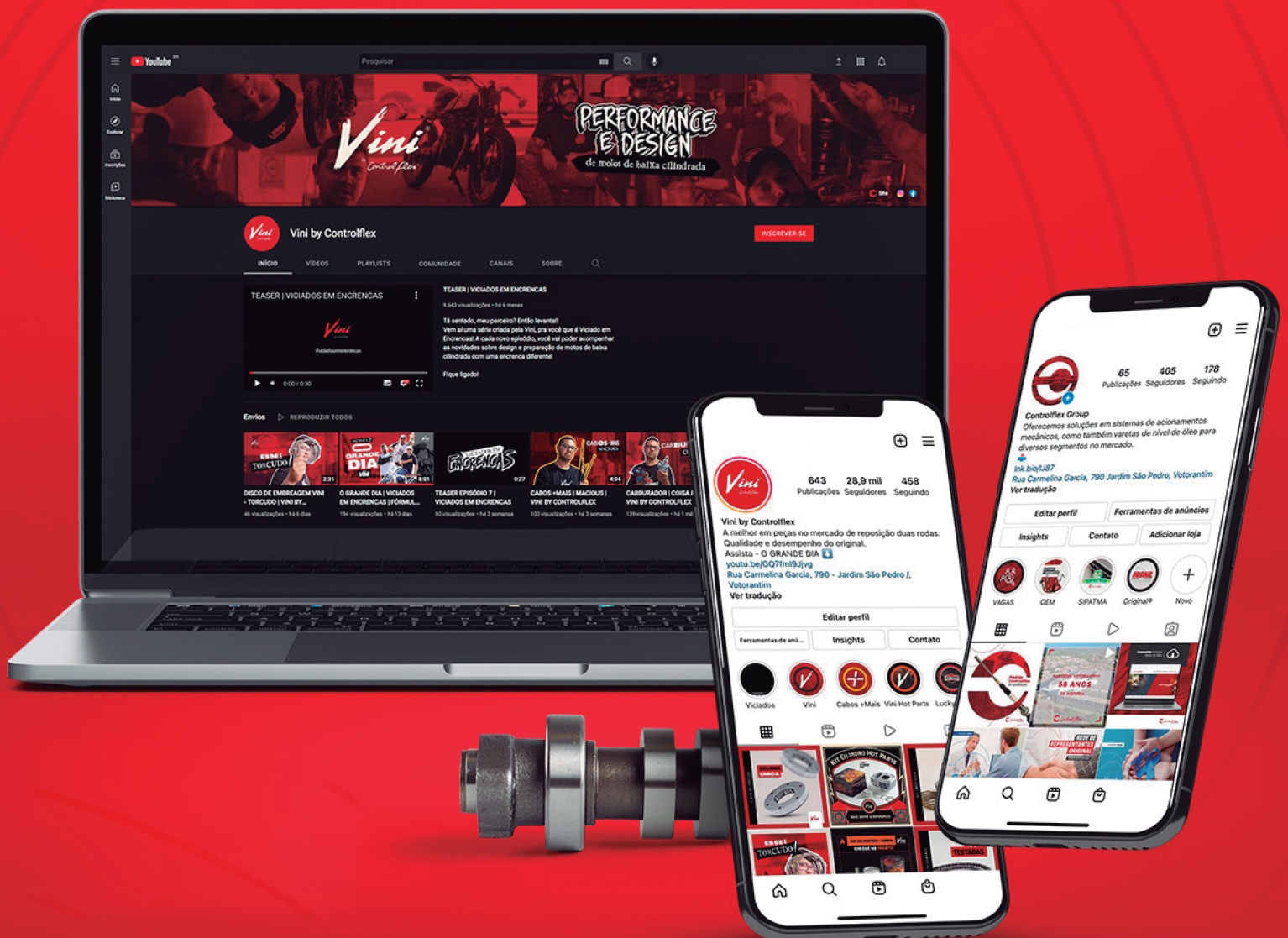

  @controlflexgroup
@controlflexcabos

 company/controlflex-group

  @vinibycontrolflex

 vinibycontrolflex



AFTERMARKET
Controlflex[®]
UMA DIVISÃO CONTROLFLEX GROUP

Controlflex[®]
Cabos Mais

Vini[®]
by Controlflex

AFTERMARKET
Controlflex[®]
UMA DIVISÃO CONTROLFLEX GROUP

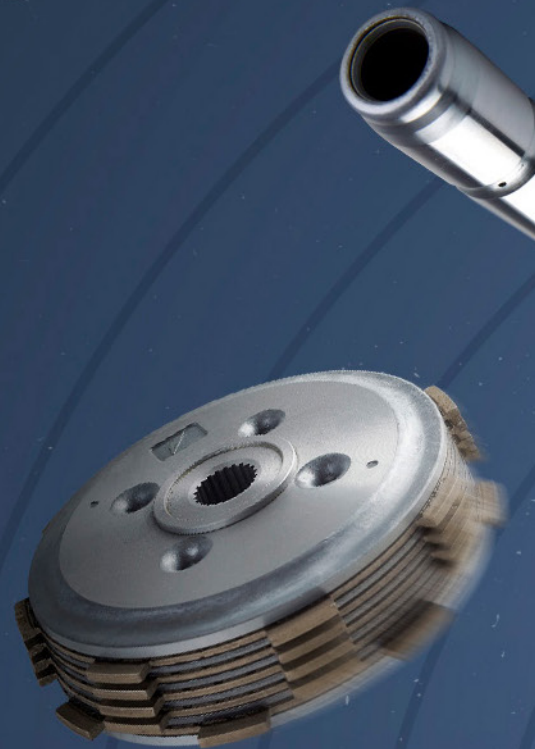

O MAIS

ALTO PADRÃO

EM MATÉRIA-PRIMA E TECNOLOGIA



VISITE NOSSO SITE

WWW.CONTROLFLEX.COM.BR/AFTERMARKET

15 3353 9070 (SAC)

SAC.AFTERMARKET@CONTROLFLEX.COM.BR

